

## California Proposition 65 Warning

### **WARNING**

Operating, servicing and maintaining a passenger vehicle or off-road vehicle can expose you to chemicals including engine exhaust, carbon monoxide, phthalates, and lead, which are known to the State of California to cause cancer and birth defects or other reproductive harm. To minimize exposure, avoid breathing exhaust, do not idle the engine except as necessary, service your vehicle in a well-ventilated area and wear gloves or wash your hands frequently when servicing your vehicle. For more information go to [www.P65Warnings.ca.gov/passenger-vehicle](http://www.P65Warnings.ca.gov/passenger-vehicle).

This manual should be considered a permanent part of the motorcycle and should remain with the motorcycle when resold or otherwise transferred to a new owner or operator. The manual contains important safety information and instructions which should be read carefully before operating the motorcycle.

## IMPORTANT

### **▲ WARNING/▲ CAUTION/ NOTICE/NOTE**

Please read this manual and follow its instructions carefully. To emphasize special information, the symbol ▲ and the words **WARNING**, **CAUTION**, **NOTICE** and **NOTE** have special meanings. Pay particular attention to messages highlighted by these signal words:

#### **▲ WARNING**

Indicates a potential hazard that could result in death or serious injury.

#### **▲ CAUTION**

Indicates a potential hazard that could result in minor or moderate injury.

#### **NOTICE**

Indicates a potential hazard that could result in vehicle or equipment damage.

*NOTE: Indicates special information to make maintenance easier or instructions clearer.*

## FOREWORD

Motorcycling is one of the most exhilarating sports and to ensure your riding enjoyment, you should become thoroughly familiar with the information presented in this Owner's Manual before riding the motorcycle.

The proper care and maintenance that your motorcycle requires is outlined in this manual. By following these instructions explicitly you will ensure a long trouble-free operating life for your motorcycle. This motorcycle also conforms to the U.S. Environmental Protection Agency emission regulations which apply to new motorcycles. The proper adjustment of engine components is necessary for this motorcycle to comply with the EPA regulations. Therefore, please follow the maintenance instructions closely to ensure emission compliance. Your Suzuki dealer has experienced technicians that are trained to provide your machine with the best possible service with the right tools and equipment.

All information, illustrations and specifications contained in this manual are based on the latest product information available at the time of publication. Due to improvements or other changes, there may be some discrepancies between information in this manual and your motorcycle. Suzuki reserves the right to make production changes at any time, without notice and without incurring any obligation to make the same or similar changes to vehicles previously built or sold.

Suzuki Motor Corporation believes in conservation and protection of Earth's natural resources. To that end, we encourage every vehicle owner to recycle, trade in, or properly dispose of, as appropriate, used motor oil, coolant, and other fluids, batteries and tires.



# TABLE OF CONTENTS

---

**THE SPORT OF MOTORCYCLING**

**1**

**FUEL, ENGINE OIL AND COOLANT RECOMMENDATIONS**

**2**

**CONTROLS**

**3**

**BREAK-IN (RUNNING-IN) AND INSPECTION BEFORE RIDING**

**4**

**RIDING TIPS**

**5**

**ACCESSORY USE AND MOTORCYCLE LOADING**

**6**

**INSPECTION AND MAINTENANCE**

**7**

**TROUBLESHOOTING**

**8**

**STORAGE PROCEDURE AND MOTORCYCLE CLEANING**

**9**

**CONSUMER INFORMATION**

**10**

**SPECIFICATIONS**

**INDEX**



# THE SPORT OF MOTORCYCLING

---

MOST ACCIDENTS CAN BE AVOIDED .....	1-2
IF YOU DON'T HAVE A HELMET, BUY A HELMET AND WEAR IT EVERY TIME YOU RIDE .....	1-2
IF A COLLISION IS IMMINENT, DO SOMETHING .....	1-3
SPECIAL SITUATIONS REQUIRE SPECIAL CARE .....	1-4
KNOW YOUR LIMITS .....	1-4
BE EXTRA SAFETY-CONSCIOUS ON BAD WEATHER DAYS .....	1-4
PRACTICE AWAY FROM TRAFFIC .....	1-5
INSPECTION BEFORE RIDING .....	1-5
ACCESSORIES AND LOADING .....	1-5
CARRYING A PASSENGER .....	1-5
MOTORCYCLE SAFETY FOUNDATION'S "RIDING TIPS AND PRACTICE GUIDE" HANDBOOK (FOR OWNERS IN USA) .....	1-5
BE STREET SMART .....	1-6
LABELS .....	1-6
CONCLUSION .....	1-6

# THE SPORT OF MOTORCYCLING

Your motorcycle and this owner's manual have been designed by people like you who enjoy motorcycling. People become motorcyclists for many reasons. For starters, street riding is fun and invigorating. But no matter why you became a motorcyclist, or how experienced you are, you will eventually face some challenging situations.

In preparing for these challenges, you will be fine-tuning your coordination, concentration, and attitude. Learning the skills and strategies associated with motorcycling is the basis for safely participating in this sport. Many motorcyclists find that as they become better riders, they also get more enjoyment from the freedom unique to motorcycling.

Please remember:

## **MOST ACCIDENTS CAN BE AVOIDED**

The most common type of motorcycle accident in the U.S. occurs when a car traveling towards a motorcycle turns left in front of the motorcycle. Is that because other drivers are out to get motorcyclists? No. Other drivers simply don't always notice motorcyclists.

Ride defensively. Wise motorcyclists use a strategy of assuming they are invisible to other drivers, even in broad daylight. Pay careful attention to other motorists, especially at intersections, because they may not be paying attention to you. Select a lane position that gives you the best view of others, and other motorists the best view of you. Wear bright, reflective clothing. Put reflective strips on your helmet.

## **IF YOU DON'T HAVE A HELMET, BUY A HELMET AND WEAR IT EVERY TIME YOU RIDE**

Most accidents occur within a few miles of home, and almost half occur at speeds of less than 30 mph. So even if you're just going on a quick errand, be prepared strap on your helmet before you take off.

Helmets do not reduce essential vision or hearing. Generally, helmets do not cause or intensify injury if you crash. Helmets simply help your skull protect your intelligence, your memory, your personality, and your life.

Your eyesight is equally valuable. Wearing suitable eye protection can help keep your vision unblurred by the wind and save your eyes from airborne hazards like bugs, dirt, or pebbles kicked up by tires.

## **IF A COLLISION IS IMMINENT, DO SOMETHING**

Many riders fear locking up their brakes or haven't learned to swerve to avoid an accident. Many inexperienced riders (and too many seasoned riders) use only their rear brake in an emergency, resulting in unnecessary impacts in some cases and unnecessarily high impact speeds in other cases. Your rear brake can only provide about 30% of your motorcycle's potential stopping power. The front and rear brakes can and should be used together to maximize braking effectiveness.

Experienced motorcyclists learn to "cover" the front brake lever by lightly resting a couple of fingers over the lever when riding in traffic and near intersections to give their reaction time a head start.

Emergency stopping and swerving are techniques that you should practice and master before you find yourself in an emergency situation. The best place to practice such techniques is in a controlled environment such as the Motorcycle Safety Foundation's (MSF) rider training courses. The MSF's Motorcycle Rider Courses (fundamental techniques) and Experienced Rider Courses (advanced strategies) present hands-on instruction of the basic principles of motorcycling and a variety of accident-avoidance maneuvers. Even a seasoned motorcyclist can improve his or her riding skills, and pick up a few new skills, through these courses. Some insurance companies even offer discounts to course graduates.



## **SPECIAL SITUATIONS REQUIRE SPECIAL CARE**

Of course, there are some times when full-force braking is not the correct technique. When the road surface is wet, loose, or rough, you should brake with care. When you're leaned over in a corner, avoid braking. Straighten up before braking. Better yet, slow down before entering the corner.

In these situations, the traction available between your tires and the road surface is limited. Over-braking when traction is limited will cause your tires to skid, possibly resulting in loss of directional control or causing you and your motorcycle to fall over.

## **KNOW YOUR LIMITS**

Always ride within the boundaries of your own skills. Knowing these limits and staying within them will help you avoid accidents.

A major cause of accidents involving only a motorcycle (and no cars) is going too fast through a turn. Before entering a turn, select an appropriately low cornering speed.

Even on straight roads, ride at a speed that is appropriate for the traffic, visibility and road conditions, your motorcycle, and your experience.

Riding a motorcycle safely requires that your mental and physical skills are fully part of the experience. You should not attempt to operate a motor vehicle, especially one with two wheels, if you are tired or under the influence of alcohol or other drugs. Alcohol, illegal drugs, and even some prescription and over-the-counter drugs can cause drowsiness, loss of coordination, loss of balance, and especially the loss of good judgment. If you are tired or under the influence of alcohol or other drugs, PLEASE DO NOT RIDE your motorcycle.

## **BE EXTRA SAFETY-CONSCIOUS ON BAD WEATHER DAYS**

Riding on bad weather days, especially wet ones, requires extra caution. Braking distances increase on a rainy day. Stay off the painted surface marks, man-hole covers, and greasy-appearing areas, as they can be especially slippery. Use extra caution at railway crossings and on metal gratings and bridges. When it starts to rain, any oil or grease on the road rises to the surface of the water. Pull over and wait a few minutes until this oil film is washed away before riding. Whenever in doubt about road conditions, slow down !

## **PRACTICE AWAY FROM TRAFFIC**

Your riding skill and your mechanical knowledge form the foundation for safe riding practices. We suggest that you practice riding your motorcycle in a non-traffic situation until you are thoroughly familiar with your machine and its controls. Again, consider taking one of the MSF's Rider Courses. Even experts will be pleased with the caliber of the information presented in these courses. As the MSF says: "The more you know, the better it gets !"

## **INSPECTION BEFORE RIDING**

Review the instructions in the "INSPECTION BEFORE RIDING" section of this manual. Perform an entire pre-ride inspection before you head out on the road.

Spending a few minutes preparing your machine for a ride can help prevent accidents due to mechanical failure or costly, inconvenient breakdowns far from home.

## **ACCESSORIES AND LOADING**

The accessories you use with your motorcycle and the manner in which you load your gear onto the bike might create hazards. Aerodynamics, handling, balance, and cornering clearance can suffer, and the suspension and tires can be overloaded. Read the "ACCESSORY USE AND MOTORCYCLE LOADING" section.

## **CARRYING A PASSENGER**

Carrying a passenger, when done correctly, is a great way to share the joy of motorcycling. You will have to alter your riding style somewhat since the extra weight of a passenger will affect handling and braking. You may also need to adjust tire pressures and suspension; please refer to the Tire Pressure and Loading section and the Suspension section for more details.

A passenger needs the same protection that you do, including a helmet and proper clothing. The passenger should not wear long shoe laces or loose pants that could get caught in the wheel. Passengers must be tall enough that their feet reach the footrests.

## **MOTORCYCLE SAFETY FOUNDATION'S "RIDING TIPS AND PRACTICE GUIDE" HANDBOOK (FOR OWNERS IN USA)**

This special handbook, supplied with your owner's manual, contains a variety of safety tips, helpful hints, and practice exercises. This manual can increase your riding enjoyment and safety. You should read it thoroughly.

## **BE STREET SMART**

Always heed speed limits, local laws, and the basic rules of the road. Set a good example for others by demonstrating a courteous attitude and a responsible riding style.

## **LABELS**

Read and follow all the labels on the motorcycle. Make sure you understand all of the labels. Do not remove any labels from the motorcycle.

## **CONCLUSION**

Traffic, road and weather conditions vary. Other motorists' actions are unpredictable. Your motorcycle's condition can change. These factors can best be dealt with by giving every ride your full attention.

Circumstances beyond your control could lead to an accident. You need to prepare for the unexpected by wearing a helmet and other protective gear, and learning emergency braking and swerving techniques to minimize the damage to you and your machine.

The best way to learn basic riding skills and evasive maneuvers or refresh your own riding skills is to take one of the courses offered by the Motorcycle Safety Foundation. Your Suzuki dealer can help you locate the fundamental or advanced riding skills course nearest you, or owners in the USA can call toll-free 1-800-446-9227.

Good riding on your new Suzuki !

# FUEL, ENGINE OIL AND COOLANT RECOMMENDATIONS

---

FUEL .....	2-2
ENGINE OIL .....	2-4
TRANSMISSION OIL .....	2-5
FINAL GEAR OIL .....	2-5
ENGINE COOLANT SOLUTION .....	2-6

# FUEL, ENGINE OIL AND COOLANT RECOMMENDATIONS

## FUEL

Your motorcycle requires unleaded gasoline with a minimum pump octane rating of 87 ((R+M)/2 method). In some areas, the only fuels that are available are oxygenated fuels.

### NOTE:

- *If the engine develops some trouble like lack of acceleration or insufficient power, the cause may be due to the fuel the motorcycle uses. In such case, try changing to a different gas station. If the situation is not improved by changing, consult your Suzuki dealer.*
- *If pinking or knocking is experienced, substitute higher octane grade gasoline or another brand, because there are differences between brands.*

Oxygenated fuels which meet the minimum octane requirement and the requirements described below may be used in your motorcycle without jeopardizing the New Vehicle Limited Warranty or the Emission Control System Warranty.

*NOTE: Oxygenated fuels are fuels which contain oxygen-carrying additives such as alcohol.*

### Gasoline/Ethanol Blends

Blends of unleaded gasoline and ethanol (grain alcohol), also known as GASOHOL, are commercially available in some areas. Blends of this type may be used in your motorcycle if they are no more than 10% ethanol (E10). Make sure this gasoline-ethanol blend has octane ratings no lower than those recommended for gasoline.

## Fuel Pump Labeling

In some states, pumps that dispense oxygenated fuels are required to be labeled for the type and percentage of oxygenate, and whether important additives are present. Such labels may provide enough information for you to determine if a particular blend of fuel meets the requirements listed above. In other states, pumps may not be clearly labeled as to the content or type of oxygenate and additives. If you are not sure that the fuel you intend to use meets these requirements, check with the service station operator or the fuel supplier.

### NOTE:

- *To help minimize air pollution, Suzuki recommends that you use oxygenated fuels.*
- *Be sure that any oxygenated fuel you use has octane ratings of at least 87 pump octane ((R+M)/2 method).*
- *If you are not satisfied with the drivability of your motorcycle when you are using an oxygenated fuel, or if engine ping-ing is experienced, substitute another brand as there are differences between brands.*

## NOTICE

**Spilled gasoline containing alcohol can damage the painted surfaces of your motorcycle.**

**Be careful not to spill any fuel when filling the fuel tank. Wipe spilled gasoline up immediately.**

## ENGINE OIL

Suzuki recommends the use of SUZUKI PERFORMANCE 4 MOTOR OIL or equivalent engine oil. If SUZUKI PERFORMANCE 4 MOTOR OIL is not available, select a proper engine oil according to the following guideline.

Oil quality is a major contributor to your engine's performance and life. Always select good quality engine oil. Use oil with an API (American Petroleum Institute) classification of SG, SH, SJ, SL, SM or SN with a JASO classification of MA.

SAE	API	JASO
10W-40	SG, SH, SJ, SL, SM or SN	MA

API: American Petroleum Institute  
JASO: Japanese Automobile Standards Organization

*NOTE: SUZUKI highly recommends the use of ECSTAR brand engine oil. ECSTAR has been specially formulated for your SUZUKI product and contributes to the desired motorcycle performance and ideal riding experience.*

## SAE Engine Oil Viscosity

Suzuki recommends the use of SAE 10W-40 engine oil. If SAE 10W-40 engine oil is not available, select an alternative according to the following chart.

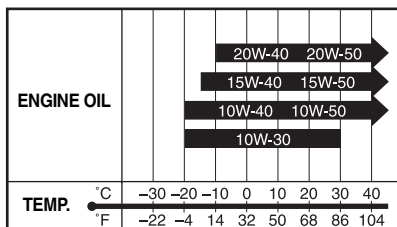

## JASO T903

The JASO T903 standard is an index to select engine oils for 4-stroke motorcycle and ATV engines. Motorcycle and ATV engines lubricate clutch and transmission gears with engine oil. JASO T903 specifies performance requirements for motorcycle and ATV clutches and transmissions.

There are two classes, MA and MB. The oil container shows the classification as follows.

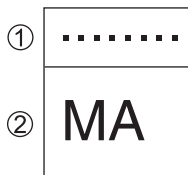

- ① Code number of oil sales company
- ② Oil classification

## Energy Conserving

Suzuki does not recommend the use of “ENERGY CONSERVING” or “RESOURCE CONSERVING” oils. Some engine oils which have an API classification of SH, SJ, SL, SM or SN have an “ENERGY CONSERVING” or “RESOURCE CONSERVING” indication in the API classification donut mark. These oils can affect engine life and clutch performance.

API SG, SH, SJ, SL, SM or SN



Recommended

API SH, SJ, SL or SM

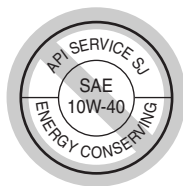

API SN



Not recommended

## TRANSMISSION OIL

Use a good quality SAE 10W-40 multi-grade motor oil.

## FINAL GEAR OIL

Use an SAE90 hypoid gear oil which is rated GL-5 under the API classification system. If you operate the motorcycle where ambient temperature is below 0°C (32°F), use an SAE80 hypoid gear oil.



## ENGINE COOLANT SOLUTION

Use “SUZUKI SUPER LONG LIFE COOLANT” or “SUZUKI LONG LIFE COOLANT”. If “SUZUKI SUPER LONG LIFE COOLANT” and “SUZUKI LONG LIFE COOLANT” are not available, use a glycol-based antifreeze compatible with an aluminum radiator mixed with distilled water only at the ratio of 50:50.

### **WARNING**

**Engine coolant is harmful or fatal if swallowed or inhaled. Solution can be poisonous to animals.**

**Do not drink antifreeze or coolant solution. If swallowed, do not induce vomiting. Immediately contact a poison control center or a physician. Avoid inhaling mist or hot vapors; if inhaled, remove to fresh air. If coolant gets in eyes, flush eyes with water and seek medical attention. Wash thoroughly after handling. Keep out of the reach of children and animals.**

## **NOTICE**

**Spilled engine coolant can damage the painted surfaces of your motorcycle.**

**Be careful not to spill any fluid when filling the radiator. Wipe spilled engine coolant up immediately.**

*NOTE: SUZUKI highly recommends the use of ECSTAR brand coolant. ECSTAR has been specially formulated for your SUZUKI product and contributes to the desired motorcycle performance and ideal riding experience.*

## ENGINE COOLANT

Engine coolant performs as a rust inhibitor and water pump lubricant as well as an anti-freeze solution. Therefore engine coolant should be used at all times even though the atmospheric temperature in your area does not go down to the freezing point.

## SUZUKI SUPER LONG LIFE COOLANT (Blue)

“SUZUKI SUPER LONG LIFE COOLANT” is pre-mixed to the proper ratio. Add only “SUZUKI SUPER LONG LIFE COOLANT” if coolant level drops. It is not necessary to dilute “SUZUKI SUPER LONG LIFE COOLANT” when replacing coolant.

## SUZUKI LONG LIFE COOLANT (Green)

### Water for Mixing

Use distilled water only. Water other than distilled water can corrode and clog the aluminum radiator.

Required amount of engine coolant/water solution capacity (total): 1600 ml (1.7 US qt)

Engine coolant	800 ml (0.8 US qt)
Water	800 ml (0.8 US qt)

*NOTE: This 50% mixture will protect the cooling system from freezing at temperatures above  $-31^{\circ}\text{C}$  ( $-24^{\circ}\text{F}$ ). If the motorcycle is to be exposed to temperature below  $-31^{\circ}\text{C}$  ( $-24^{\circ}\text{F}$ ), this mixing ratio should be increased up to 55% ( $-40^{\circ}\text{C}/-40^{\circ}\text{F}$ ) or 60% ( $-55^{\circ}\text{C}/-67^{\circ}\text{F}$ ) coolant. The mixing ratio should not exceed 60% coolant.*



# CONTROLS

---

LOCATION OF PARTS .....	3-2
KEY .....	3-5
IGNITION SWITCH .....	3-5
INSTRUMENT PANEL .....	3-8
LEFT HANDLEBAR .....	3-20
RIGHT HANDLEBAR .....	3-25
BRAKE LOCK LEVER .....	3-27
FUEL TANK CAP .....	3-28
FRONT TRUNK .....	3-29
FRONT SMALL BOX .....	3-30
TRUNK .....	3-31
HELMET HOLDER .....	3-31
BACKREST ADJUSTMENT .....	3-32
TRUNK BOX LIGHT SWITCH .....	3-32
STAND .....	3-33
REAR SUSPENSION .....	3-34
OUTPUT TERMINAL .....	3-34

# CONTROLS

## LOCATION OF PARTS

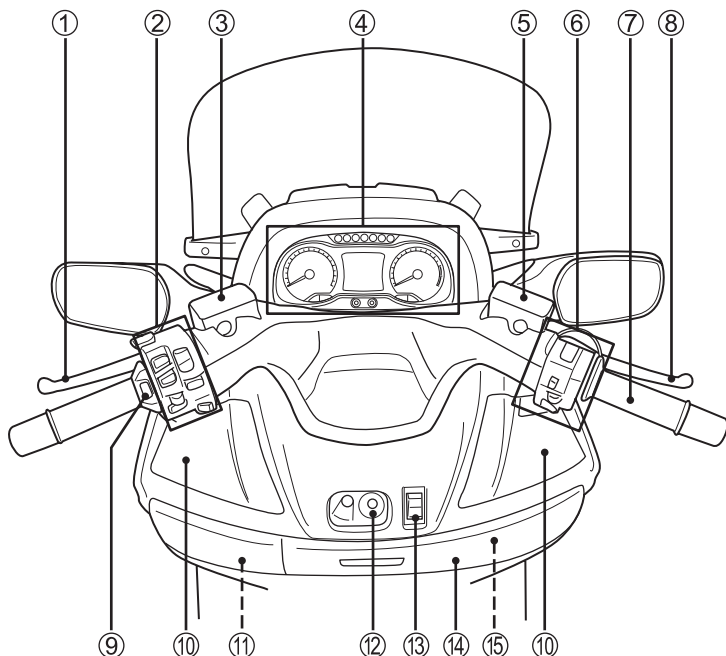

- ① Rear brake lever
- ② Left handlebar switches
- ③ Rear brake fluid reservoir
- ④ Instrument panel
- ⑤ Front brake fluid reservoir
- ⑥ Right handlebar switches
- ⑦ Throttle grip
- ⑧ Front brake lever
- ⑨ Grip heater switch
- ⑩ Front small box
- ⑪ Air cleaner, Fuses
- ⑫ Ignition switch
- ⑬ Seat heater switch
- ⑭ Front trunk
- ⑮ Output terminal

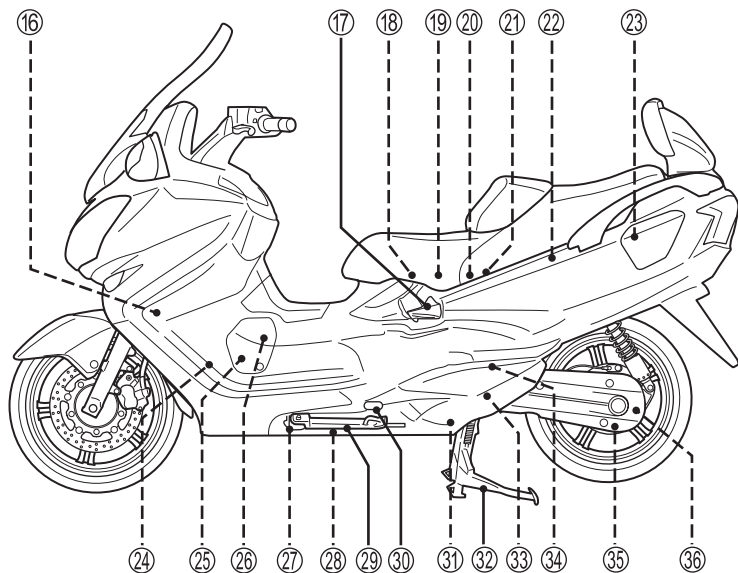

- |                                 |                              |
|---------------------------------|------------------------------|
| ①⑥ Air cleaner drain plugs      | ③⑤ Final gear oil drain plug |
| ①⑦ Brake lock lever             | ③⑥ Final gear oil level plug |
| ①⑧ Battery                      |                              |
| ①⑨ Tools                        |                              |
| ②⑩ Helmet holder                |                              |
| ②① Fuses                        |                              |
| ②② Trunk                        |                              |
| ②③ Fuel tank cap                |                              |
| ②④ Spark plugs                  |                              |
| ②⑤ Engine coolant reservoir     |                              |
| ②⑥ Engine oil filler cap        |                              |
| ②⑦ Engine oil filter            |                              |
| ②⑧ Engine oil drain plug        |                              |
| ②⑨ Side stand                   |                              |
| ③⑩ Engine oil inspection window |                              |
| ③① Transmission oil drain plug  |                              |
| ③② Center stand                 |                              |
| ③③ Transmission oil level plug  |                              |
| ③④ Transmission oil filler plug |                              |

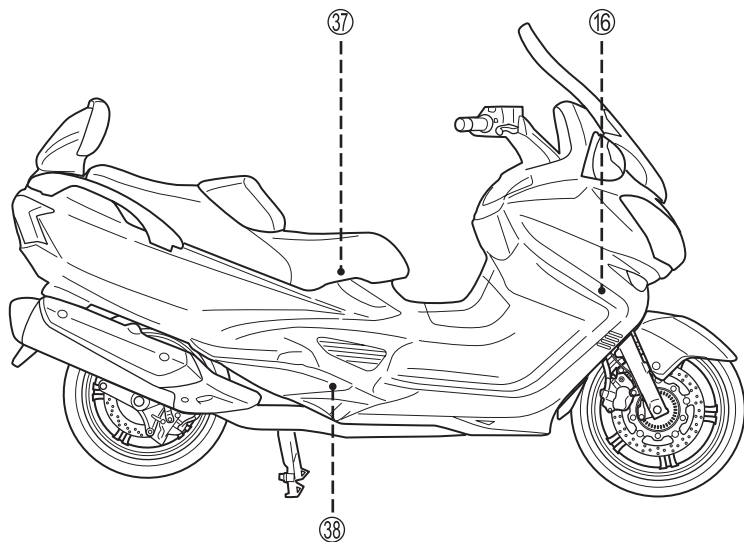

- ③⑦ Main fuse, CVT fuse
- ③⑧ CVT filter

## KEY

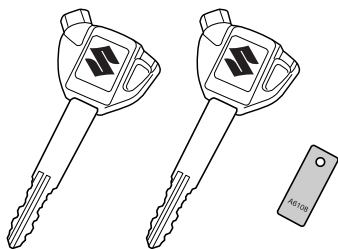

This motorcycle comes equipped with a pair of identical ignition keys. Keep the spare key in a safe place.

The key number is stamped on a plate provided with the keys. This number is used when making replacement keys. Please write your key number in the box provided for your future reference.

Key No.:

## IGNITION SWITCH

To open the ignition key-hole shutter:

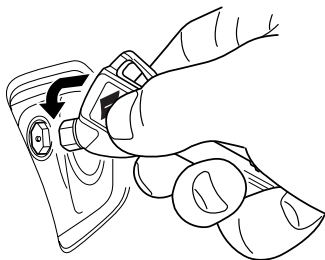

1. Match the ignition key head to the square hole on the ignition switch.
2. Turn the key to open and close the key-hole shutter.

**NOTE:** Apply anti-freeze lubricant when atmospheric temperature drops below freezing to avoid ignition key-hole shutter freezing.



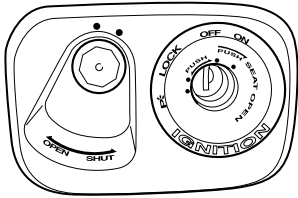

### “OFF” Position

All electrical circuits are cut off. The engine will not start. The key can be removed.

### “ON” Position

The ignition circuit is completed and the engine can now be started. The key cannot be removed from the ignition switch.

*NOTE: Start the engine promptly after turning the key to the “ON” position, or the battery will lose power due to consumption by the headlight and taillight.*

### “LOCK” Position

To lock the steering, turn the handlebar all the way to the left. Push the key in and turn it to the “LOCK” position and remove the key. All electrical circuits are cut off.

### “P” (Parking) Position

When parking the motorcycle, lock the steering and turn the key to the “P” position. The key can now be removed and the position light and taillight will remain lit and the steering will be locked. This position is for night time roadside parking to increase visibility.

## **WARNING**

**Turning the ignition switch to the “P” (PARKING) or “LOCK” position while the motorcycle is moving can be hazardous. Moving the motorcycle while the steering is locked can be hazardous. You could lose your balance and fall, or you could drop the motorcycle.**

**Stop the motorcycle and place it on the side stand or center stand before locking the steering. Never attempt to move the motorcycle when the steering is locked.**

## **⚠ WARNING**

If the motorcycle falls down due to a slip or collision, unexpected damage to the motorcycle could cause the engine to keep running, which could result in a fire, or could result in injury from moving parts such as the rear wheel.

If the motorcycle falls down, turn the ignition switch off immediately. Ask your authorized Suzuki dealer to inspect the motorcycle for unseen damage.

### **Seat Lock Release**

Push the key in and turn it clockwise to release the seat lock.

#### **NOTE:**

- *Open the seat fully until it stops. If the seat is stopped halfway, seat can be closed with its weight.*
- *Push the center part of the seat rear end downward when closing the seat.*

### **SEAT HEATER SWITCH “”**

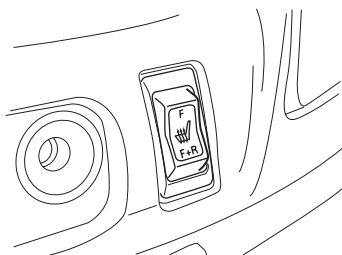

The seat heater warms front and rear seats. The seat heater switch is located on the front panel.

The seat heater switch has 3 positions: F, OFF and F + R.

#### **F (Front) position**

The front seat will be warmed up.

#### **OFF position**

The seat heater switch will be cut off.

#### **F (Front) + R (Rear) position**

Both the front and rear seats will be warmed up.

*NOTE: The seat heater uses battery power. Turn off the seat heater switch when the engine is not running.*

## INSTRUMENT PANEL

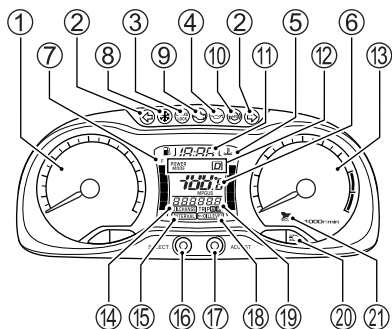

### SPEEDOMETER ①

The speedometer indicates road speed in mph or km/h.

If the meter needle does not point to zero, follow the procedure below to reset the meter.

1. Press and hold the ADJUST button ⑰ and turn on the ignition switch.
2. Hold the ADJUST button ⑰ for 4 seconds.

### TURN SIGNAL INDICATOR LIGHT “↔” ②

When the turn signals are being operated either to the right or to the left, the indicator light will blink intermittently.

*NOTE: If a turn signal light is not operating properly due to bulb filament or circuit failure, the indicator will blink quickly to warn the rider of the existence of a problem.*

### BRAKE LOCK INDICATOR LIGHT ③

This light comes on when the parking brake is applied and the ignition switch is in the “ON” position.

### OIL PRESSURE INDICATOR LIGHT “” ④

This indicator comes on when the engine oil pressure is below the normal operating range. This light should come on when the ignition switch is “ON” and the engine is not running. As soon as the engine starts, this indicator light should go out.

## NOTICE

**After starting the engine, opening the throttle or running the motorcycle with the oil pressure indicator light turned on, may adversely affect the engine.**

**Make sure that the oil pressure indicator light has turned off before operating the throttle or running the motorcycle.**

## NOTICE

Riding the motorcycle with the oil pressure indicator light lit can damage the engine and transmission.

If the oil pressure indicator light comes on, indicating low oil pressure, stop the engine immediately. Check the oil level and add oil if necessary. If there is a proper amount of oil and the light still does not go out, have your authorized Suzuki dealer or a qualified mechanic inspect your motorcycle.

## ENGINE COOLANT TEMPERATURE INDICATOR

“” ⑤

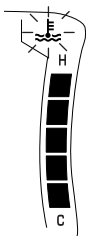

The coolant temperature is displayed by an LCD segment temperature indicator ⑤ and coolant temperature mark.

When the coolant temperature exceeds 248°F (120°C), all five LCD segments turn on and the coolant temperature mark blinks. If all five LCD segments for temperature indication ⑤ turn on and the coolant temperature mark blinks, stop the engine, wait until the engine is cooled, and check the coolant level.

## NOTICE

Riding the motorcycle with the coolant temperature mark blinking can cause serious engine damage due to overheating.

If the coolant temperature mark blinks, stop the engine to let it cool. Do not run the engine until the coolant temperature mark turns off.

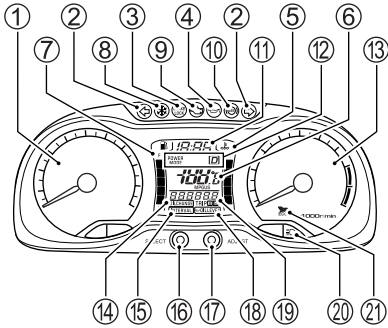

**THERMOMETER/  
FUEL CONSUMPTION METER/  
GEAR POSITION INDICATOR  
(MANUAL mode only) ⑥**

To change the display, push the ADJUST button ⑰. The display change in the order below:

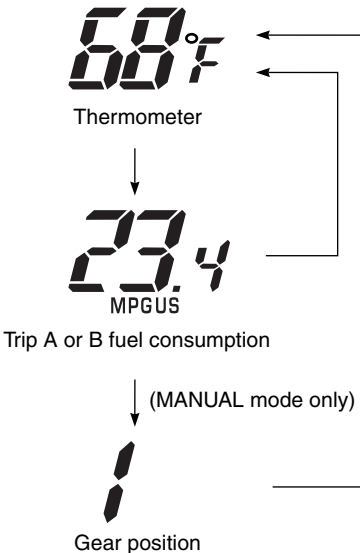

The display has three functions, thermometer, fuel consumption meter and gear position indicator (MANUAL mode only).

**Thermometer**

The thermometer shows the ambient air temperature. When the ambient air temperature is below 38°F (3°C), the thermometer blinks in the display ⑥ and it comes on and remains lit after 30 seconds. Push the ADJUST button ⑰ to return to original reading. When the ambient air temperature is above 41°F (5°C), the display will return to original reading automatically.

**NOTE:**

- The thermometer will not indicate the actual ambient air temperature when riding at low speed or when stopped.
- The thermometer displays “Lo” when the ambient air temperature is below 14°F (-10°C). The thermometer displays “Hi” when the ambient air temperature is above 122°F (50°C).
- In gear position indicator mode, when the ambient air temperature is below 38°F (3°C), the thermometer blinks for 30 seconds, and then display will return to original reading automatically.

## Fuel Consumption Meter

Fuel consumption meter displays fuel consumption ratio of trip A and trip B. The fuel consumption meter ranges from 0.1 to 99.9 MPG US. The meter locks at 99.9. The fuel consumption meter indicates “- - . -” when the trip meter indicates 0.0.

*NOTE: The display shows estimated values. Indications may not be the same as actual values.*

### **WARNING**

**Changing the display while riding can be hazardous. Removing a hand from the handlebars can reduce your ability to control the motorcycle.**

**Never change the display while riding. Keep both hands on the handlebars.**







## Gear Position Indicator (MANUAL mode only)

The gear position indicator display indicates gear position when the MANUAL mode is selected.

## FUEL LEVEL INDICATOR “”

⑦

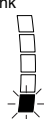
The fuel level indicator indicates the amount of fuel remaining in the fuel tank. The fuel level indicator displays all 5 segments when the fuel tank is full. The mark blinks when the fuel level drops below 4.0 L (4.2 US qt). The mark and segment blink when the fuel drops below 2.0 L (2.1 US qt).

Fuel tank	Approximately 2.0 L	Approximately 4.0 L	Full
 mark			
Segment			

*NOTE: The fuel level indicator will not indicate correctly when the motorcycle is placed on the side stand. Turn the ignition switch to the “ON” position when the motorcycle is held upright.*

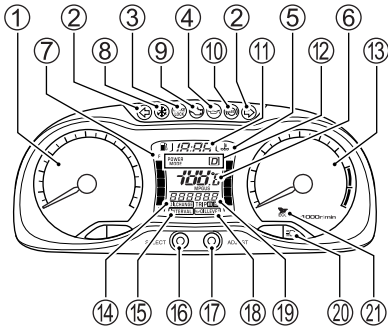

### FREEZE INDICATOR LIGHT

“❄️” ⑧

The freeze indicator light ⑧ starts blinking when the ambient temperature falls below 38°F (3°C). The freeze indicator light keeps flashing for 30 seconds and then remains lit until the ambient temperature rises above 41°F (5°C).

Freeze indicator light ⑧ goes off when the ambient temperature becomes above 41°F (5°C).

### MALFUNCTION AND CVT SYSTEM INDICATOR LIGHT

“🔧” ⑨

FI

If the fuel injection system or CVT system fails, the malfunction indicator light ⑨ comes on and the display ⑱ indicates “FI” in the odometer display area in following two modes;

- A. The display ⑱ in the odometer display area alternately indicates “FI” and the odometer/trip meter reading, and the malfunction indicator light ⑨ comes on and remains lit.
- B. The display ⑱ in the odometer display area indicates “FI” continuously and the malfunction indicator light ⑨ blinks.

The engine may continue to run in mode A, but the engine may not run in mode B.

## NOTICE

The malfunction and CVT indicator light comes on to indicate a problem with the fuel injection system or CVT system. Riding the motorcycle with the indicator lit can damage the engine and CVT.

If the display indicates “FI” and the malfunction indicator light comes on, have your authorized Suzuki dealer or a qualified mechanic inspect the fuel injection and CVT system as soon as possible.

# CHEC

When the display ⑱ indicates “CHEC”, make sure that the engine stop switch is in the “O” position.

If the display still indicates “CHEC” after above procedure, inspect the ignition fuse and connection of lead wire couplers.

*NOTE: If the display indicates “FI” and the odometer/trip meter alternately, and the malfunction indicator light comes on and remains lit, keep the engine running and bring your motorcycle to an authorized Suzuki dealer. If the engine stalls, try restarting the engine after turning the ignition switch off and on.*



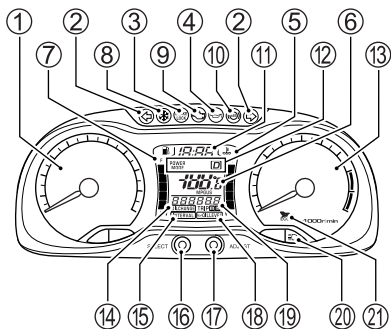

### **ABS INDICATOR LIGHT “(ABS)” ⑩**

This indicator normally comes on when the ignition switch is turned “ON” and goes off after the motorcycle speed exceeds 3 mph (5 km/h).

If there is a problem with the ABS (Anti-lock Brake System), this indicator light blinks or comes on. The ABS does not operate when the ABS indicator light is on or blinking.

#### **NOTE:**

- *If the ABS indicator light goes off after you start the motorcycle but before you begin riding, check the ABS indicator light function by turning off and on the ignition switch. The ABS indicator light can go off if the engine is revved at high speed before you begin riding. If the ABS indicator light does not come on when the ignition switch is turned on, you should have the system checked by an authorized Suzuki dealer as soon as possible.*

- *When the motorcycle is placed on the center stand with the engine running after riding the motorcycle and racing the engine, the ABS indicator light can come on. In such a case, check if the ABS indicator light comes on by turning off and on the ignition switch. After that, check if the ABS indicator light goes out after the motorcycle speed exceeds 3 mph (5 km/h). If the ABS indicator light does not go out, you should have the system checked by an authorized Suzuki dealer as soon as possible.*

## **▲ WARNING**

**Riding the motorcycle with the ABS indicator light on can be hazardous.**

**If the ABS indicator light blinks or comes on while riding, stop the motorcycle in a safe place and turn off the ignition switch. Turn the ignition switch “ON” after a while and check if the indicator light comes on.**

- **If the indicator light goes off after starting to ride, the ABS will be functioning.**
- **If it does not go off after starting to ride, ABS is not functioning, and the brakes provide normal stopping ability. You should have the system checked by an authorized Suzuki dealer as soon as possible.**

## CLOCK ⑪



Press and hold the SELECT ⑯ and ADJUST ⑰ buttons simultaneously for 2 seconds until the clock display blinks when adjusting clock. Push the SELECT button ⑯ to adjust the hour display. Push the ADJUST button ⑰ to adjust the minute display. Press and hold the SELECT ⑯ and ADJUST ⑰ buttons simultaneously for 2 seconds to return to the clock mode.

### NOTE:

- When the button is pressed and held, display will increase continuously.
- The clock can be adjusted when the ignition switch is in the "ON" position.
- This clock is powered by the battery of the motorcycle. If your motorcycle is to be left unused more than two months, remove the battery from the motorcycle.

## DRIVE MODE INDICATOR ⑫

POWER  
MODE

D

Drive mode: For normal riding and better fuel economy.

Power mode: For sport riding and getting more power.

## TACHOMETER ⑬

The tachometer indicates the engine speed in revolutions per minute (r/min).

If the meter needle does not point to zero, follow the procedure below to reset the meter.

1. Press and hold the ADJUST button ⑰ and turn on the ignition switch.
2. Hold the ADJUST button ⑰ for 4 seconds.

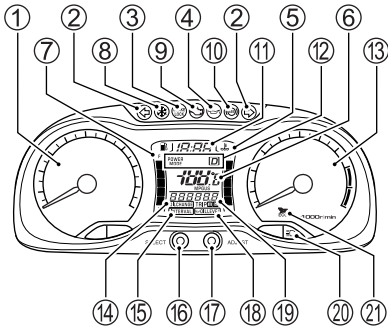

### OIL CHANGE INDICATOR ⑭



The oil change indicator comes on to remind you to change the engine oil. The indicator comes on at initial 600 miles (1000 km) and preset intervals thereafter. The preset interval is adjustable between 300 miles (500 km) and 3600 miles (6000 km) in 300 mile (500 km) steps. Reset the indicator after changing the engine oil to turn off the indicator.

To reset the oil change indicator:

1. Turn off the ignition switch.
2. Press and hold the SELECT button ⑯ and turn the ignition switch to the "ON" position and hold the SELECT button ⑯ for 3 seconds.
3. The oil change counter will reset and the OIL CHANGE indicator ⑭ blinks 3 times and goes off.

To preset the oil change interval:

1. Set the meter to odometer, then press and hold the ADJUST button ⑰ for 2 seconds until the INTERVAL ⑮ and OIL CHANGE ⑭ indicators blink.
2. Push the SELECT button ⑯ to decrease the interval from 3600 miles (6000 km) to 300 miles (500 km) in 300 mile (500 km) steps.
3. Push the ADJUST button ⑰ to increase the interval from 300 miles to 3600 miles (6000 km) in 300 mile (500 km) steps.
4. Press and hold the SELECT ⑯ and the ADJUST ⑰ buttons for 2 seconds.

**NOTE:**

- *The preset interval can be adjusted after odometer reaches 600 miles (1000 km).*
- *Reset the indicator after initial engine oil replacement.*
- *Reset the indicator after oil replacement even if the indicator is not displayed.*
- *Preset interval change does not reset the indicator.*

**OIL LEVEL INDICATOR 18**



The oil level indicator comes on when the engine oil level is below the normal operating range. When the engine oil level indicator comes on, check the engine oil level through oil level inspection window described in this owner's manual. Add engine oil if the oil level is below the specified range.

*NOTE: The engine oil level in the crankcase changes while riding. Quick acceleration, hard braking and hill climbing will change engine oil level. This oil level change can trigger the engine oil level indicator. The indicator will also come on if the motorcycle tips over. These cases are not oil level indicator malfunction.*

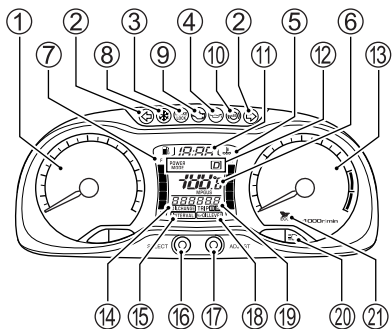

### ODOMETER/TRIP METER ⑱

The display has two functions, odometer and trip meter.



To change the display, push the SELECT button ⑯. The display changes in the order below:

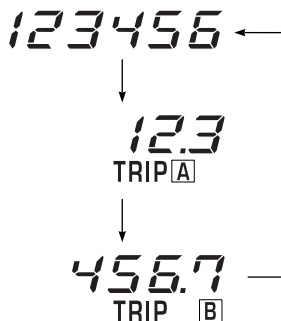

### Odometer

The odometer registers the total distance that the motorcycle has been ridden. The odometer ranges from 0 to 999999.

*NOTE: The odometer display locks at 999999 when the total distance exceeds 999999.*

### Trip meter

The trip meter is a resettable odometer. It can be used for indicating the distance traveled on short trips or between fuel stops. To reset a trip meter to zero, push the ADJUST button ⑰ for 2 seconds.

*NOTE: When the trip meter exceeds 9999.9, the trip meter will return to 0.0 and start counting again.*

## HIGH BEAM INDICATOR LIGHT

“” (20)

The blue indicator light will be lit when the headlight high beam is turned on.

## ECO DRIVE INDICATOR LIGHT

“” (21)

The AN650Z has an Eco Drive Indicator to encourage riding that may reduce environmental impacts. The Eco Drive Indicator light, located on the instrument panel, will come on when the motorcycle is operated in a fuel-efficient manner - and may help riders learn techniques to improve their fuel economy.

The Eco Drive Indicator is active when the AN650Z is operated in the Drive mode, but disabled when in the Manual mode. The system monitors the motorcycle's real-time fuel consumption rate and illuminates the Eco Drive Indicator light when this rate is below predetermined fuel consumption rates.

The Eco Drive Indicator does not automatically improve fuel economy but may help riders refine their riding efficiency and improve fuel economy. Fuel economy can be affected by many outside factors, such as the distance traveled and traffic conditions, e.g., the number of starts from a stop. Equally important are other factors affecting fuel economy that are within the driver's control, including such things as the rate of acceleration (throttle use), chosen speed, and maintenance.

## LEFT HANDLEBAR

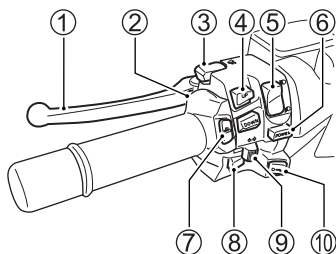

### REAR BRAKE LEVER ①

The rear brake is applied by squeezing the rear brake lever gently towards the grip. The brake light will be lit when the lever is squeezed inward.

## Rear Brake Lever Adjustment

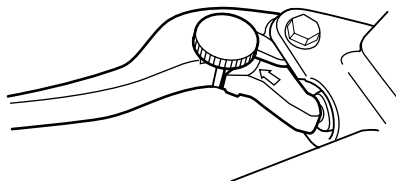

The distance between the grip and the rear brake lever is adjustable to 5 positions. To change the position, push the brake lever forward and turn the adjuster to the desired position. When changing the brake lever position, always be sure the adjuster stops in the proper position; a projection of the brake lever pivot should fit into the depression of the adjuster. This motorcycle is delivered from the factory with its adjuster set on position 3.

### **WARNING**

Adjusting the rear brake lever position while riding can be hazardous. Removing a hand from the handlebars can reduce your ability to control the motorcycle.

Never adjust the rear brake lever position while riding. Keep both hands on the handlebars.

## HEADLIGHT FLASHER SWITCH

②

Press the switch to flash the headlight.

## REAR VIEW MIRROR FOLDING SWITCH “” ③

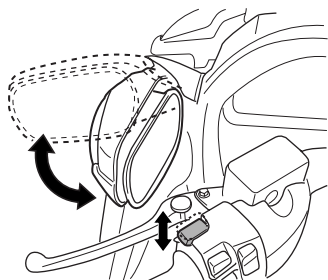

Push the switch to fold the rear view mirrors backward for parking in restricted areas. Push the switch to extend the rear view mirrors.

### **WARNING**

Riding the motorcycle with the rear view mirrors folded will be hazardous.

Extend both right and left rear view mirrors before starting off.

## SHIFT SWITCH ④

In manual mode, pushing upper switch will shift up the transmission and pushing the lower switch will shift down the transmission. The transmission will be shifted down automatically when the motorcycle speed is decreased.

*NOTE: Gear position indicator blinks 3 times when the shift change is not acceptable due to the desired gear being out of transmission speed range.*

### **NOTICE**

In manual mode, the transmission will not be shifted up automatically.

Never allow the engine to rev into the red zone.



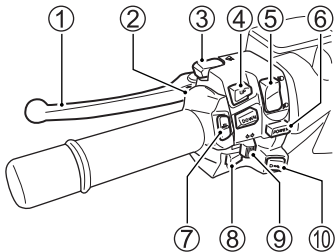

## DIMMER SWITCH ⑤

### “” position

The headlight low beam turns on.

### “” position

The headlight high beam turns on. The high beam indicator light also turns on.

## **NOTICE**

Sticking tape or placing objects in front of the headlight can obstruct headlight heat radiation. This can result in headlight damage.

Do not stick tape on the headlight or place objects in front of the headlight.

## **NOTICE**

Do not put objects in front of the headlight or taillight when they are on, and do not cover with clothes when the motorcycle is stopped.

This may cause melting of the lens or damage to the object by the heat from the lens.

## DRIVE MODE SWITCH ⑥

Drive mode: For normal riding and better fuel economy.

Power mode: For sport riding and getting more power.

## GRIP HEATER SWITCH ⑦

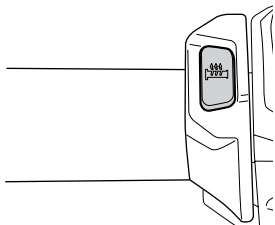

Grip heater warms right and left grips when the grip heater switch is turned on with the engine running. The grip heater switch will be turned off when the ignition switch is turned off.

The grip heater temperature can be adjusted in three steps each time the grip heater switch is pressed and held. The grip heater temperature changes as follows, and the LED indicator blinks.

1. 100%: LED indicator blinks 3 times  
(7 set)



2. 80%: LED indicator blinks 2 times  
(7 set)



3. 60%: LED indicator blinks 7 times



OFF: LED indicator turns off

## **WARNING**

Improperly using the grip heater can be hazardous. Rider can suffer burns even if the heating temperature is fairly low when the rider is wearing no gloves and leaves the heater on for long periods. Damaged grip can suffer burns or get an electrical shock.

- Be sure to wear gloves to avoid burns.
- Replace the damaged grips to avoid burns or electrical shock.

### NOTE:

- The grip heater has a built-in automatic switch to avoid unnecessary battery power consumption. The automatic switch turns off grip heater when the engine speed becomes lower at engine idling speed. When the engine speed increases, the automatic switch turns on grip heater.
- Pushing the switch will not turn on the grip heater when the engine speed is low. Increase the engine speed and push the switch again to turn on the grip heater.

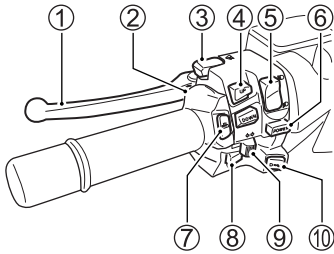



### **HORN SWITCH “” ⑧**

Press the switch to sound the horn.

### **TURN SIGNAL LIGHT SWITCH**

“” ⑨

Moving the switch to the “” position will flash the left turn signals. Moving the switch to the “” position will flash the right turn signals. The indicator light will also flash intermittently. Push in the switch to cancel the turn signal operation.

## **WARNING**

**Failure to use the turn signals, and failure to turn off the turn signals can be hazardous. Other drivers may misjudge your course and this may result in an accident.**

**Always use the turn signals when you intend to change lanes or make a turn. Be sure to turn off the turn signals after completing the turn or lane change.**

### **SHIFT MODE CHANGE SWITCH**

“” ⑩

Push the shift mode change switch to change from DRIVE mode to MANUAL mode and vice versa.

**DRIVE mode:**

The drive mode indicator in the instrument panel shows D. The transmission shifts automatically.

**MANUAL mode:**

The gear position indicator shows a numeral. The transmission can be changed by pushing the shift switch ④.

## RIGHT HANDLEBAR

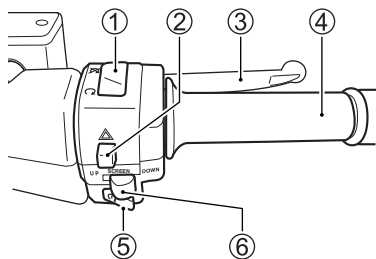

### ENGINE STOP SWITCH ①

#### “” position

The ignition circuit is off. The engine cannot start or run.

#### “” position

The ignition circuit is on and the engine can run.

### HAZARD WARNING SWITCH

#### “” ②

All four turn signal lights and indicators will flash simultaneously when the switch is turned on with the ignition switch in the “ON” or “P” position. Use the hazard warning lights to warn other traffic during emergency parking or when your vehicle could otherwise become a traffic hazard.

### FRONT BRAKE LEVER ③

The brake is applied by squeezing the front brake lever gently towards the grip. The brake light will be lit when the lever is squeezed inward.

## Front Brake Lever Adjustment

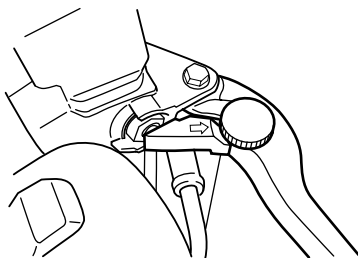

The distance between the throttle grip and the front brake lever is adjustable to 5 positions. To change the position, push the brake lever forward and turn the adjuster to the desired position. When changing the brake lever position, always be sure the adjuster stops in the proper position; a projection of the brake lever pivot should fit into the depression of the adjuster. This motorcycle is delivered from the factory with its adjuster set on position 3.

## WARNING

Adjusting the front brake lever position while riding can be hazardous. Removing a hand from the handlebars can reduce your ability to control the motorcycle.

Never adjust the front brake lever position while riding. Keep both hands on the handlebars.

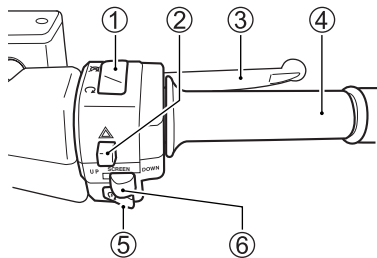

### THROTTLE GRIP ④

Engine speed is controlled by the position of the throttle grip. Twist it towards you to increase engine speed. Turn it away from you to decrease engine speed.

### ELECTRIC STARTER SWITCH

“” ⑤

Push in the electric starter switch to operate the starter motor.

*NOTE: If the brake lever is not squeezed, the starter motor will not operate.*

*NOTE: This motorcycle is equipped with an interlock system for the ignition circuit and the starter circuit. The engine can only be started if the side stand is fully up.*

*NOTE: The headlight will go off when the electric starter switch is pushed.*

## NOTICE

Engaging the starter motor for more than five seconds at a time can damage the starter motor and wiring harness from overheating.

Do not engage the starter motor for more than five seconds at a time. If the engine does not start after several attempts, check the fuel supply and ignition system. Refer to the TROUBLESHOOTING section in this manual.

### POWER WINDSHIELD SWITCH

⑥

Windshield height can be adjusted by power windshield switch.

## WARNING

Operating power windshield on someone's hands or fingers can cause serious injury.

Make sure nobody is touching windshield before operating the power windshield switch.

## BRAKE LOCK LEVER

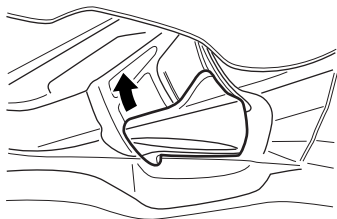

Use the brake lock to help prevent the motorcycle from moving when it is parked, being started, or idling. To operate the brake lock lever, pull the lever all the way toward you. The brake lock indicator light will come on when the brake lock lever is engaged. To release the brake lock lever, pull the lever and release it.

### **⚠ WARNING**

Riding the motorcycle with the brake lock lever engaged is hazardous. The rear brake will overheat and it will reduce braking performance.

Use the brake lock lever only when parking and release the lever before riding.

### **⚠ WARNING**

Operating the brake lock lever while riding can be hazardous. Removing a hand from the handlebars can reduce your ability to control the motorcycle. Operating the brake lock lever while riding can cause rear wheel skid and loss of control.

Always keep both hands on the handlebars during riding.

## FUEL TANK CAP

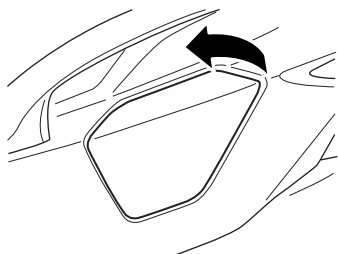

Open the lid.

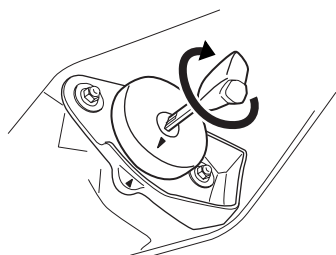

Insert the key and turn it clockwise to open the fuel tank cap with the key still held in a position, lift up on the key and remove the cap. To install the fuel tank cap, face the triangle mark towards you and line up the fuel tank cap guide pins. Push down the fuel tank cap until the locking pins click into position. The key must be in the cap lock before installing the cap.

Use fresh gasoline when filling up the fuel tank. Do not use bad gasoline which is contaminated with dirt, dust, water or other liquid. Be careful that dirt, dust or water does not enter the fuel tank when refueling.

*NOTE: The fuel tank has a pressure regulator around the fuel tank inlet to release pressure when the fuel tank becomes hot. The fuel tank pressure regulator may whistle when it releases fuel tank pressure.*

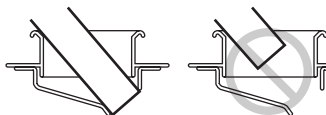

### NOTE:

- When refueling, hold the tip of fuel nozzle against crossbar in fuel inlet as illustration.
- Stop filling the fuel tank after the fuel nozzle automatically clicks off. Do not try to “top off” the fuel tank. Leave some room for the fuel to expand from temperature increase.

## **⚠ WARNING**

Failure to follow safety precautions when refueling could result in a fire or cause you to breathe toxic fumes.

Refuel in a well ventilated area. Make sure the engine is off and avoid spilling fuel on a hot engine. Do not smoke, and make sure there are no open flames or sparks in the area. Avoid breathing gasoline vapors. Keep children and pets away when you refuel the motorcycle.

## **FRONT TRUNK**

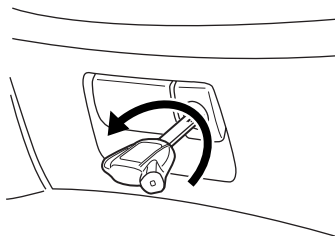

To open the lid:

1. Insert the ignition key and turn it counterclockwise to unlock the latch lever.
2. Pull the latch lever.

To close the lid:

1. Push the box lid firmly until the latch snaps into the position.
2. Turn the ignition key clockwise to lock the latch lever.
3. Remove the key.
4. Pull the latch lever and check that the box lid is locked.

The box load capacity is 1.5 kg (3.0 lbs).



## **⚠ WARNING**

If the box lid is not locked, it may open while riding.

Make sure the box lid is closed and locked securely.

## **⚠ WARNING**

Opening the box lid while riding can be hazardous. Removing a hand from the handlebars can reduce your ability to control the motorcycle.

Always keep both hands on the handlebars during operation.

## **FRONT SMALL BOX**

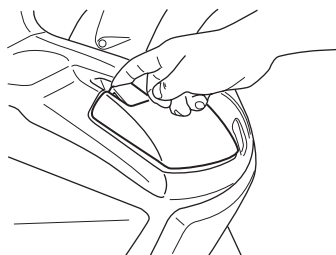

Pull the latch lever to open the lid. Pull the latch lever and push the lid to close the lid.

The box load capacity is 0.5 kg (1 lbs).

## **⚠ WARNING**

Opening the box lid while riding can be hazardous. Removing a hand from the handlebars can reduce your ability to control the motorcycle.

Always keep both hands on the handlebars during operation.

## TRUNK

The trunk load capacity is 10 kg (22 lbs).

### **⚠ WARNING**

**Overloading the motorcycle will decrease riding stability and can lead to loss of control.**

**Never exceed the load capacity.**

*NOTE: Do not allow water to get inside the trunk, or damage may occur.*

#### **NOTE:**

- Do not keep any low heat-resistant items in the trunk since the trunk may get hot.
- Do not keep valuable items in the trunk when leaving the motorcycle unattended.
- Do not put valuable items in the trunk because the trunk is not watertight.
- Push down the rear end of the seat if the seat does not unlock with key operation.

Place helmets as shown, or seat may not be completely locked.

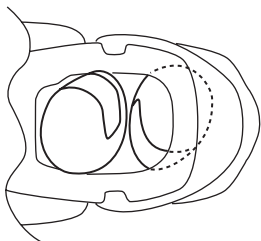

## HELMET HOLDER

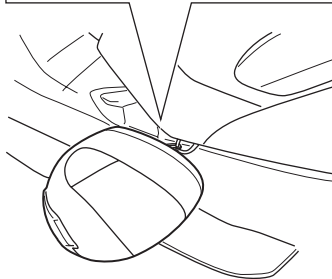
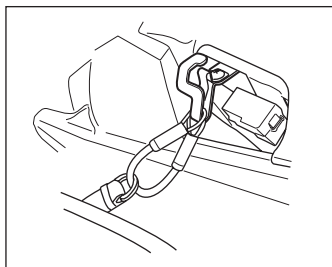

Use cable (included) and hook cable through helmet strap "D" rings and around helmet holder.

## BACKREST ADJUSTMENT

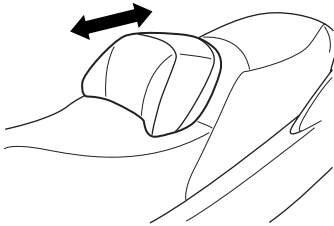
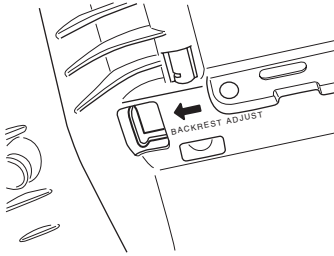

The backrest adjustment lever is located under the seat. To adjust the backrest position, move the adjustment lever and slide the backrest forward or rearward. Try to move the backrest forward and rearward to ensure that it is securely latched.

*NOTE: Return the adjustment lever by hand to lock the backrest.*

## TRUNK BOX LIGHT SWITCH

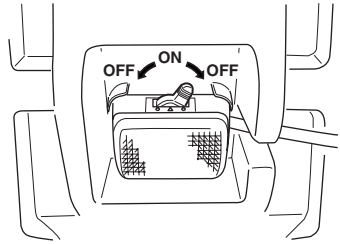

### **“ON” position**

The trunk box light turns on.

### **“OFF” position**

The trunk box light turns off.

## STAND

This motorcycle is equipped with a center stand and side stand.

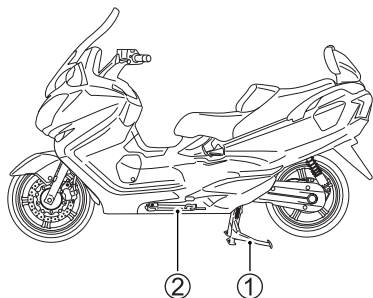

### CENTER STAND ①

To place the motorcycle on the center stand, place your foot on the stand extension and then rock the motorcycle to the rear and upward with the passenger hand rail with your right hand, while steadying the handlebars with your left hand.

*NOTE: The transmission cannot shift when the motorcycle is placed on the center stand. Ride and move the motorcycle to inspect shift operation.*

### SIDE STAND ②

An interlock system is provided to cut off the ignition circuit when the side stand is down.

The side stand/ignition interlock system works as follows:

- If the side stand is down, the engine can not be started.
- If the engine is running and the side stand is put down, the engine will stop running.

## ▲ WARNING

Riding with the side stand incompletely retracted can result in an accident when you turn left.

Check operation of the side stand/ignition interlock system before riding. Always retract the side stand completely before starting off.

## NOTICE

Park the motorcycle on firm, level ground to help prevent it from falling over.

If you must park on an incline, aim the front of the motorcycle uphill and apply the brake lock to reduce the possibility of rolling off the side stand. For better security, place the motorcycle on the center stand.

## REAR SUSPENSION

### SPRING ADJUSTMENT

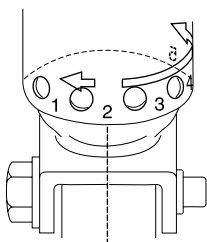
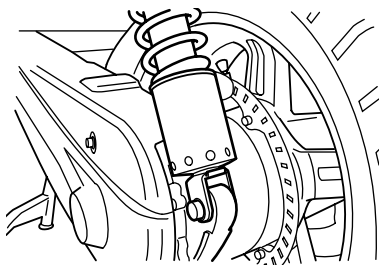

To adjust the spring pre-load, turn the adjuster clockwise or counter-clockwise to the desired position. Position 1 provides the softest spring pre-load and position 5 provides the stiffest. This motorcycle is delivered from the factory with its adjuster set on position 2.

### **⚠ WARNING**

**Unequal suspension adjustment can cause poor handling and instability.**

**Adjust the right and left shock absorbers to the same settings.**

## OUTPUT TERMINAL

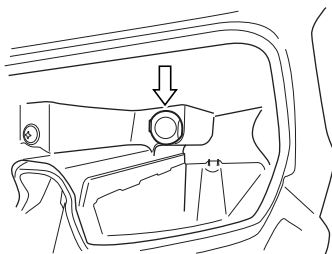

AN650Z has an output terminal for attaching 12V electrical accessories. Total electrical accessory wattage should be less than 36W. Check electrical accessory voltage and wattage before attaching accessories to the output terminal.

### **NOTICE**

**Using improper electrical accessories can damage your motorcycle. Exceeding 36W or using other than a 12V accessory can seriously damage the electrical system and accessory.**

**Check voltage and wattage before connecting electrical accessories.**

*NOTE: The trunk lid may not latch closed if a long type plug is inserted into the output terminal.*

# BREAK-IN (RUNNING-IN) AND INSPECTION BEFORE RIDING

---

BREAK-IN .....	4-2
INSPECTION BEFORE RIDING .....	4-3

## BREAK-IN (RUNNING-IN) AND INSPECTION BEFORE RIDING

### BREAK-IN

The foreword explains how important proper break-in is to achieve maximum life and performance from your new Suzuki. The following guidelines explain proper break-in procedures.

### MAXIMUM THROTTLE OPERATION RECOMMENDATION

This table shows the maximum recommended throttle operation during the break-in period.

Initial	800 km (500 miles)	Below 4000 r/min
Up to	1600 km (1000 miles)	Below 6000 r/min
Over	1600 km (1000 miles)	Below 8000 r/min

### VARY THE ENGINE SPEED

The engine speed should be varied and not held at a constant speed. This allows the parts to be "loaded" with pressure, and then unloaded, allowing the parts to cool. This aids the mating process of the parts. It is essential that some stress be placed on the engine components during break-in to ensure this mating process. Do not, though, apply excessive load on the engine.

### BREAKING IN THE NEW TIRES

New tires need proper break-in to assure maximum performance, just as the engine does. Wear in the tread surface by gradually increasing your cornering lean angles over the first 160 km (100 miles) before attempting maximum performance. Avoid hard acceleration, hard cornering, and hard braking for the first 160 km (100 miles).

### WARNING

Failure to perform break-in of the tires could cause tire slip and loss of control.

Use extra care when riding on new tires. Perform proper break-in of the tires as described in this section and avoid hard acceleration, hard cornering, and hard braking for the first 160 km (100 miles).

### AVOID CONSTANT LOW SPEED

Operating the engine at constant low speed (light load) can cause parts to glaze and not seat in. Allow the engine to accelerate freely through the gears, without exceeding the recommended maximum limits. Do not, however, use full throttle for the first 160 km (100 miles).

## **ALLOW THE ENGINE OIL TO CIRCULATE BEFORE RIDING**

Allow sufficient idling time after warm or cold engine start-up before applying load or revving the engine. This allows time for the lubricating oil to reach all critical engine components.

## **OBSERVE YOUR FIRST AND MOST CRITICAL SERVICE**

The 1000 km (600 miles) service is the most important service your motorcycle will receive. During break-in all of the engine components will have worn in and all of the other parts will have seated in. All adjustments will be restored, all fasteners will be tightened, and the dirty oil will be replaced.

Timely performance of the 1000 km (600 miles) service will ensure optimum service life and performance from the engine.

*NOTE: The 1000 km (600 miles) service should be performed as outlined in the Maintenance Schedule section of this Owner's Manual. Pay particular attention to the caution and warning messages in MAINTENANCE SCHEDULE section.*

## **INSPECTION BEFORE RIDING**

### **WARNING**

Failure to inspect your motorcycle before riding and to properly maintain your motorcycle increases the chances of an accident or equipment damage.

Always inspect your motorcycle each time you use it to make sure it is in safe operating condition. Refer to the **INSPECTION AND MAINTENANCE** section in this owner's manual.

### **WARNING**

If you operate this motorcycle with improper tires or improper or uneven tire pressure, you may lose control of the motorcycle. This will increase your risk of an accident.

Always use tires of the size and type specified in this owner's manual. Always maintain proper tire pressure as described in the **INSPECTION AND MAINTENANCE** section.











Before riding the motorcycle, be sure to check the following items. Never underestimate the importance of these checks. Perform all of them before riding the machine.

## **WARNING**

**Checking maintenance items when the engine is running can be hazardous. You could be severely injured if your hands or clothing get caught in moving engine parts.**

**Shut the engine off when performing maintenance checks, except when checking the lights, engine stop switch, and throttle.**

WHAT TO CHECK	CHECK FOR:
Steering	<ul style="list-style-type: none"> <li>• Smoothness</li> <li>• No restriction of movement</li> <li>• No play or looseness</li> </ul>
Brakes (  3-20, 3-25, 3-27, 7-29)	<ul style="list-style-type: none"> <li>• Proper lever operation</li> <li>• Fluid level in the reservoir to be above "LOWER" line</li> <li>• No fluid leakage</li> <li>• Brake pads not worn down to the limit line</li> <li>• Correct lever play</li> <li>• No "sponginess"</li> <li>• No dragging</li> <li>• Brake lock operation</li> </ul>
Tires (  7-33)	<ul style="list-style-type: none"> <li>• Proper pressure</li> <li>• Adequate tread depth</li> <li>• No cracks or cuts</li> </ul>
Fuel (  3-11)	Enough fuel for the planned distance of operation
Lighting (  3-5, 3-8, 3-20, 3-25)	Operation of all lights and indicators
Horn (  3-24)	Correct function
Engine oil (  7-21)	Correct level
Throttle (  7-16)	<ul style="list-style-type: none"> <li>• Correct play in the throttle cable</li> <li>• Smooth operation and positive return of the throttle grip to the closed position</li> </ul>
Side stand/ Ignition interlock system (  7-36)	Proper operation
Windshield (  3-26, 9-6)	Good visibility

**NOTE:** *The transmission cannot shift when the motorcycle is placed on the center stand. Ride and move the motorcycle to inspect shift operation.*

# RIDING TIPS

---

STARTING THE ENGINE .....	5-2
STARTING OFF .....	5-4
RIDING ON HILLS (MANUAL mode) .....	5-5
STOPPING AND PARKING .....	5-5

## RIDING TIPS

### STARTING THE ENGINE

Sit on the motorcycle and retract the side stand, or place the motorcycle on the center stand. Insert the ignition key into the ignition switch and turn it to the "ON" position. Set the brake lock.

#### **WARNING**

**Starting the engine improperly can be hazardous. Starting the engine without engaging the brake lock can allow the motorcycle to move forward as soon as the engine starts.**

**Always set the brake lock and apply the rear brake before starting the engine.**

*NOTE: This motorcycle is equipped with an interlock system for the ignition circuit and the starter circuit. The engine can only be started if the side stand is fully up.*

*NOTE: The fuel supply system stops the engine when the motorcycle is overturned. Turn off the ignition switch before restarting the engine.*

### When the Engine is Cold:

1. Squeeze the front or rear brake lever.
2. Close the throttle completely and push the electric starter switch.
3. After the engine starts, let the engine run until the engine sufficiently warms up.

### When the Engine is Warm:

1. Squeeze the front or rear brake lever.
2. Close the throttle completely and push the electric starter switch.
3. After the engine starts, let the engine run until the engine sufficiently warms up.

### When a Warm Engine is Hard to Start:

1. Squeeze the front or rear brake lever.
2. Open the throttle grip 1/8 to 1/4, push the electric starter switch.
3. After the engine starts, let the engine run until the engine sufficiently warms up.

## **⚠ WARNING**

Exhaust gas contains carbon monoxide, a dangerous gas that is difficult to detect because it is colorless and odorless. Breathing carbon monoxide can cause death or severe injury.

Never start the engine or let it run indoors or where there is little or no ventilation.

## ***NOTICE***

After starting the engine, opening the throttle or running the motorcycle with the oil pressure indicator light turned on, may adversely affect the engine.

Make sure that the oil pressure indicator light has turned off before operating the throttle or running the motorcycle.

## ***NOTICE***

Running the engine too long without riding may cause the engine to overheat. Overheating can result in damage to internal engine components and discoloration of exhaust pipes.

Shut the engine off if you cannot begin your ride promptly.

## STARTING OFF

### **WARNING**

Riding at excessive speeds increases your chances of losing control of the motorcycle, which can result in an accident.

Always ride at a speed that is proper for the terrain, visibility and operating conditions, and your skills and experience.

### **WARNING**

If you remove even one hand or foot from the motorcycle, you can reduce your ability to control the motorcycle. This could cause you to lose your balance and fall off the motorcycle. If you remove a foot from a footrest, your foot or leg may come in contact with the rear wheel. This could injure you or cause an accident.

Always keep both hands on the handlebars and both feet on the footrests of your motorcycle during operation.

Close the throttle and apply the brake when taking the motorcycle off the center stand. Release the brake lock. Open the throttle grip toward you and the motorcycle will start moving forward.

*NOTE: When the CVT belt is new the engine rpm may jump briefly under hard acceleration due to the smoothness of the belt.*

### **WARNING**

Sudden side winds, which can occur when being passed by larger vehicles, at tunnel exits or in hilly areas, can cause you to lose control of the motorcycle.

Reduce your speed and be alert to the possibility of sudden side winds.

## RIDING ON HILLS (MANUAL mode)

- When climbing steep hills, the motorcycle may begin to slow down and show lack of power. At this point you should shift to a lower gear so that the engine will again be operating in its normal power range. Shift rapidly to prevent the motorcycle from losing momentum.
- When descending a long, steep slope, use the engine compression to assist the brakes by shifting to a lower gear. Continuous brake application can overheat the brakes and reduce their effectiveness.
- Be careful, however, not to allow the engine to over rev.

## STOPPING AND PARKING

### **Anti-lock Brake System (ABS)**

This model is equipped with an Anti-lock Brake System (ABS) designed to help prevent wheel lock up during hard braking or during braking on slippery surfaces while riding in a straight line.

The ABS will operate whenever it senses that the wheels are locking up. You may feel the brake lever pulsate lightly while the ABS is operating.

Even though ABS helps prevent wheel lock-up, you must still be careful when braking in curves. Hard braking while turning could cause wheel skidding and loss of control, whether or not your motorcycle is equipped with ABS. Having ABS does not mean you can take unnecessary risks. ABS will not compensate for poor judgment, incorrect braking techniques, or not slowing down over bad roads or in poor weather conditions.

You must still ride sensibly and alertly.

On regular paved roads, some riders may be able to obtain slightly shorter stopping distances with conventional brake systems than with ABS.

*NOTE: In some situations, a motorcycle with ABS may require a longer stopping distance to stop on loose or uneven surfaces than an equivalent motorcycle without ABS.*

## **WARNING**

Inexperienced riders tend to underutilize the front brake. This can cause excessive stopping distance and lead to a collision. Using only the front or rear brake can cause skidding and loss of control.

Apply both brakes evenly and at the same time.

## **WARNING**

Braking while turning the motorcycle can be hazardous, whether or not your motorcycle is equipped with ABS. ABS can not control wheel side-slips that occur when you brake hard while turning and the side-slips could cause loss of control.

Slow down sufficiently in a straight line before you begin to turn and avoid other than slight braking while turning.

## **WARNING**

Failure to use good judgment with ABS can be hazardous. ABS cannot make up for bad road conditions, bad judgment, or improper operation of the brakes.

Remember that ABS will not compensate for poor judgment, incorrect braking techniques, or the need to slow down over bad roads or in poor weather conditions. Use good judgment and do not ride faster than conditions will safely allow.

## How the ABS Works

ABS works by electronically controlling braking pressure. A computer monitors wheel rotation speed. If the computer detects that a braked wheel has slowed suddenly, indicating a skidding situation, the computer will reduce braking pressure to prevent that wheel from locking up. ABS works automatically, so you do not need any special braking technique. Just squeeze the front brake lever and rear brake lever, as forcefully as necessary for the situation, without pumping either one. It is normal for the brake levers to pulsate while the ABS is operating.

Non-recommended tires can affect wheel speed and may confuse the computer.

ABS does not work at very low speed, less than 5 mph (8 km/h), and does not work with a discharged battery.

## Stopping and Parking

1. Twist the throttle grip away from yourself to close the throttle completely.
2. Apply the front and rear brakes evenly and at the same time.

### **WARNING**

**Inexperienced riders tend to underutilize the front brake. This can cause excessive stopping distance and lead to a collision. Using only the front or rear brake can cause skidding and loss of control.**

**Apply both brake levers evenly and at the same time.**

### **WARNING**

**Hard braking while turning may cause wheel skid and loss of control.**

**Brake before you begin to turn.**

### **WARNING**

**Hard braking on wet, loose, rough, or other slippery surfaces can cause wheel skid and loss of control.**

**Brake lightly and with care on slippery or irregular surfaces.**



## **WARNING**

Following another vehicle too closely can lead to a collision. As vehicle speeds increase, stopping distance increases progressively.

Always maintain a safe stopping distance between you and the vehicle in front of you.

## **NOTICE**

Holding the motorcycle stopped with throttle operation on inclines can damage the motorcycle's clutch.

Use the brakes when stopping the motorcycle on inclines.

3. Park the motorcycle on a firm, flat surface where it will not fall over.
4. Apply the side stand or center stand.
5. Turn the ignition switch to the "OFF" position to stop the engine.
6. Turn the ignition switch to the "LOCK" position to lock the steering.
7. Set the brake lock.
8. Remove the ignition key from the switch.

*NOTE: If an optional anti-theft lock such as an U-shape lock, brake disk lock or chain is used to avoid theft, be sure to remove the anti-theft lock before moving the motorcycle.*

## **CAUTION**

A hot muffler can cause severe burns. The muffler will be hot enough to cause burns for some time after stopping the engine.

Park the motorcycle where pedestrians or children are not likely to touch the muffler.

## **NOTICE**

Direct sunlight magnified through windshields and other transparent parts can damage the motorcycle.

Park the motorcycle in the shade or cover it with a motorcycle cover.

# ACCESSORY USE AND MOTORCYCLE LOADING

---

ACCESSORY USE .....	6-2
ACCESSORY INSTALLATION GUIDELINES .....	6-2
LOADING LIMIT .....	6-3
LOADING GUIDELINES .....	6-4
MODIFICATION .....	6-5

## ACCESSORY USE AND MOTORCYCLE LOADING

### ACCESSORY USE

The addition of unsuitable accessories can lead to unsafe operating conditions. It is not possible for Suzuki to test each accessory on the market or combinations of all the available accessories; however, your dealer can assist you in selecting quality accessories and installing them correctly. Use extreme caution when selecting and installing the accessories on your motorcycle and consult your Suzuki dealer if you have any questions.

### **WARNING**

**Improper installation of accessories or modification of the motorcycle may cause changes in handling which could lead to an accident.**

**Never use improper accessories, and make sure that any accessories that are used are properly installed. All parts and accessories added to the motorcycle should be genuine Suzuki parts or their equivalent designed for use on this motorcycle. Install and use them according to their instructions. If you have any questions, contact your Suzuki dealer.**

## ACCESSORY INSTALLATION GUIDELINES

- Install aerodynamic-affecting accessories, such as a fairing, windshield, backrests, saddlebags, and travel trunks, as low as possible, as close to the motorcycle and as near to the center of gravity as is feasible. Check that the mounting brackets and other attachment hardware are rigidly mounted.
- Inspect for proper ground clearance and bank angle. Inspect that the accessory does not interfere with the operation of the suspension, steering or other control operations.
- Accessories fitted to the handlebars or the front fork area can create serious stability problems. The extra weight will cause the motorcycle to be less responsive to your steering control. The weight may also cause oscillations in the front end and lead to instability problems. Accessories added to the handlebars or front fork of the machine should be as light as possible and kept to a minimum.

- Certain accessories displace the rider from his or her normal riding position. This limits the freedom of movement of the rider and may limit control ability.
- Additional electrical accessories may overload the existing electrical system. Severe overloads may damage the wiring harness or create a hazardous situation due to the loss of electrical power during the operation of the motorcycle.
- Do not pull a trailer or sidecar. This motorcycle is not designed to pull a trailer or sidecar.

## LOADING LIMIT

### **WARNING**

**Overloading or improper loading can cause loss of motorcycle control and an accident.**

**Follow loading limits and loading guidelines in this manual.**

- Never exceed the GVWR (Gross Vehicle Weight Rating) of this motorcycle. The GVWR is the combined weight of the machine, accessories, payload, rider and passenger. When selecting your accessories, keep in mind the weight of the riders as well as the weight of the accessories. The additional weight of the accessories may not only create an unsafe riding condition but may also affect the steering ease.

GVWR: 460 kg (1014 lbs) at the tire pressure (cold)

Front: 225 kPa

(2.25 kgf/cm<sup>2</sup>, 33 psi)

Rear: 280 kPa

(2.80 kgf/cm<sup>2</sup>, 41 psi)

## **NOTICE**

**Riding of the motorcycle surpassing the G.V.W.R may cause damage or failure of component parts of the drive system.**

**Be careful not to surpass the conditions established in G.V.W.R when riding or loading the motorcycle.**

## **LOADING GUIDELINES**

This motorcycle is primarily intended to carry small items when you are not riding with a passenger. Follow the loading guidelines below:

- Balance the load between the left and right side of the motorcycle and fasten it securely.
- Keep cargo weight low and as close to the center of the motorcycle as possible.
- Do not attach large or heavy items to the handlebars, front forks or rear fender.
- Do not install a luggage carrier or a luggage box protruding over the tail end of the motorcycle.
- Do not carry any items that protrude over the tail end of the motorcycle.
- Check that both tires are properly inflated to the specified tire pressure for your loading conditions. Refer to page 7-34.
- Improperly loading your motorcycle can reduce your ability to balance and steer the motorcycle. You should ride at reduced speeds, less than 130 km/h (80 mph), when you are carrying cargo or have added accessories.
- Adjust suspension setting as necessary.

## **WARNING**

Placing objects in the space behind the fairing can interfere with steering and can cause loss of control.

**Do not carry any objects in the space behind the fairing.**

## **MODIFICATION**

Modification of the vehicle or removal of original equipment may render the vehicle unsafe or illegal. Obey all applicable regulations in your area including federal and state regulations regarding environmental protection.

Suzuki's limited warranties may not cover damage caused by modifications that would change the original vehicle specifications including, without limitation, modifications of any emission-related parts such as the carburetor(s), fuel injection system components, the engine control module, air suction system components, the catalytic converter (if equipped), evaporative emission control system components (such as the carbon canister, fuel tank, fuel hoses and vapor hoses), etc.

**It is strictly prohibited to modify a vehicle by installing parts that can affect emissions control, except in accordance with very specific U.S. Environmental Protection Agency and California Air Resources Board regulations.**



# INSPECTION AND MAINTENANCE

---

MAINTENANCE SCHEDULE .....	7-2
TOOLS .....	7-6
LUBRICATION POINTS .....	7-6
BATTERY .....	7-7
SPARK PLUG .....	7-10
AIR CLEANER .....	7-13
ENGINE IDLE SPEED INSPECTION .....	7-16
THROTTLE CABLE PLAY .....	7-16
CVT FILTER .....	7-17
ENGINE COOLANT .....	7-19
ENGINE OIL .....	7-21
TRANSMISSION OIL AND FINAL GEAR OIL .....	7-26
BRAKES .....	7-29
TIRES .....	7-33
SIDE STAND/IGNITION INTERLOCK SYSTEM .....	7-36
LIGHT BULB REPLACEMENT .....	7-37
FUSES .....	7-42
CATALYTIC CONVERTER .....	7-44



## INSPECTION AND MAINTENANCE

**MAINTENANCE, REPLACEMENT OR REPAIR OF THE EMISSION CONTROL DEVICES AND SYSTEMS MAY BE PERFORMED BY ANY MOTORCYCLE REPAIR ESTABLISHMENT OR INDIVIDUAL USING ANY MOTORCYCLE PART WHICH HAS BEEN CERTIFIED UNDER THE PROVISIONS IN THE CLEAN AIR ACT Sec. 207 (a)(2).**

## MAINTENANCE SCHEDULE

The chart indicates the intervals between periodic services in miles (kilometers) and months. At the end of each interval, be sure to inspect, check, lubricate and service as instructed. If your motorcycle is used under high stress conditions such as continuous full throttle operation, or is operated in a dusty climate, certain services should be performed more often to ensure reliability of the machine as explained in the maintenance section. Your Suzuki dealer can provide you with further guidelines. Steering components, suspension and wheel components are key items and require very special and careful servicing. For maximum safety we suggest that you have these items inspected and serviced by your authorized Suzuki dealer or qualified service mechanic.

## **⚠ WARNING**

Improper maintenance or failure to perform recommended maintenance can lead to an accident.

Keep your motorcycle in good condition. Ask your Suzuki dealer or a qualified mechanic to perform the maintenance items marked with an asterisk (\*). You may perform the unmarked maintenance items by referring to the instructions in this section, if you have mechanical experience. If you are not sure how to do any of the jobs, ask your Suzuki dealer to do the maintenance.

## **⚠ WARNING**

Exhaust gas contains carbon monoxide, a dangerous gas that is difficult to detect because it is colorless and odorless. Breathing carbon monoxide can cause death or severe injury.

Never start the engine or let it run indoors or where there is little or no ventilation.

## **NOTICE**

Servicing electric parts with the ignition switch in the "ON" position can damage the electric parts when the electric circuit is shorted.

Turn off the ignition switch before servicing the electric parts to avoid short-circuit damage.

## **NOTICE**

Poorly-made replacement parts can cause your motorcycle to wear more quickly and may shorten its useful life.

When replacing parts on your vehicle, use only genuine Suzuki replacement parts or their equivalent.

*NOTE: The MAINTENANCE CHART specifies the minimum requirements for maintenance. If you use your motorcycle under severe conditions, perform maintenance more often than shown in the chart. If you have any questions regarding maintenance intervals, consult your Suzuki dealer or a qualified mechanic.*

## MAINTENANCE CHART

Interval: This interval should be judged by number of months or odometer reading, whichever comes first.

Interval		months	2	12	24	36	48
		km	1000	6000	12000	18000	24000
		miles	600	4000	7500	11000	14500
* Valve clearance			–	–	–	–	I
Spark plug (🔧 7-10)			–	I	R	I	R
* Exhaust pipe bolts and muffler bolts			T	–	T	–	T
Air cleaner element (🔧 7-13)			–	I	I	R	I
Throttle cable play (🔧 7-16)			I	I	I	I	I
* Throttle valve synchronization			I (CA. only)	–	I	–	I
* Evaporative emission control system (California model only)			–	–	I	–	I
		Replace vapor hose every 4 years					
* PAIR (air supply) system			–	–	I	–	I
CVT filter (🔧 7-17)			–	–	I	–	I
Radiator hose (🔧 7-20)			–	I	I	I	I
		*Replace every 4 years					
* Engine coolant (🔧 7-19)	“SUZUKI SUPER LONG LIFE COOLANT” (Blue)	Replace every 4 years or 48000 km (29000 miles)					
	“SUZUKI LONG LIFE COOLANT” (Green) or an engine coolant other than “SUZUKI SUPER LONG LIFE COOLANT” (Blue)		–	–	R	–	R
* Fuel hose			–	I	I	I	I
		Replace every 4 years					
Engine oil (🔧 7-21)			R	R	R	R	R
Engine oil filter (🔧 7-21)			R	–	–	R	–
Transmission oil (🔧 7-26)			R	–	R	–	R
Final gear oil (🔧 7-26)			R	–	R	–	R

Item	Interval	months	2	12	24	36	48
		km	1000	6000	12000	18000	24000
		miles	600	4000	7500	11000	14500
* Brakes (☞ 7-29)							
Brake hose (☞ 7-29)		-					
	*Replace every 4 years						
Brake fluid (☞ 7-30)		-					
	*Replace every 2 years						
* Steering			-		-		
* Front forks		-	-		-		
* Rear suspension (☞ 3-34)		-	-		-		
Tires (☞ 7-33)		-					
* Chassis bolts and nuts		T	T	T	T	T	T
Lubrication (☞ 7-6)	Lubricate every 1000 km (600 miles)						

**NOTE:** I= Inspect and clean, adjust, replace or lubricate as necessary;  
R= Replace; T= Tighten

**NOTE:** (California model only) and (CA. only) means that the items or the maintenance interval is to be applied only for the California model.

## TOOLS

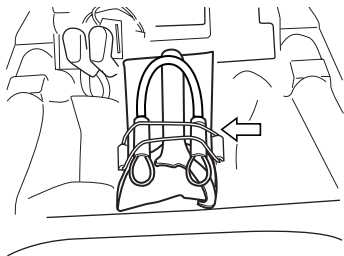

A tool kit is supplied and located under the seat.

## LUBRICATION POINTS

Proper lubrication is important for smooth and long life of each working part of your motorcycle and also for safe riding. It is a good practice to lubricate the motorcycle after a long rough ride and after getting it wet in the rain or after washing it. Major lubrication points are indicated below.

### ***NOTICE***

**Lubricating electrical switches can damage the switches.**

**Do not apply grease or oil to electrical switches.**

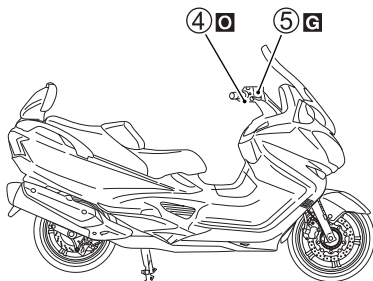
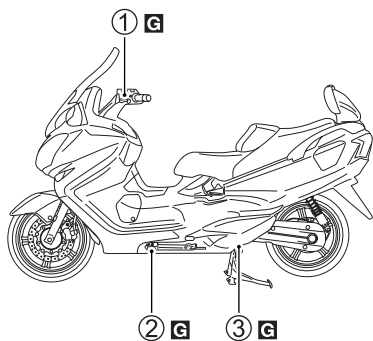

- O** .... Motor oil
- G** .... Grease

- ① .... Rear brake lever pivot
- ② .... Side stand pivot and spring hook
- ③ .... Center stand pivot and spring hook
- ④ .... Throttle cable
- ⑤ .... Front brake lever pivot

## BATTERY

The battery is located under the seat. The battery is a sealed type battery and requires no maintenance of fluid level and gravity. However, have your dealer check charging condition periodically.

The standard charging rate is  $1.4A \times 5$  to 10 hours and the maximum rate is  $6A \times 1$  hour. Never exceed the maximum charging rate.

### **▲ WARNING**

Battery posts, terminals, and related accessories contain lead and lead compounds. Lead is harmful to your health if it gets into your blood stream.

Wash hands after handling any parts containing lead.

### **▲ WARNING**

Diluted sulfuric acid from the battery can cause blindness or severe burns.

When working near the battery, use proper eye protection and gloves. Flush eyes or body with ample water and get medical care immediately if you suffer injury. Keep batteries out of reach of children.

## **⚠ WARNING**

Batteries produce flammable hydrogen gas which can explode if exposed to flames or sparks.

Keep flames and sparks away from the battery. Never smoke when working near the battery.

## **NOTICE**

Exceeding the maximum charging rate for the battery can shorten its life.

Never exceed the maximum charging rate for the battery.

## **⚠ WARNING**

Wiping the battery with a dry cloth can cause a static electricity spark, which can start a fire.

Wipe the battery with a damp cloth to avoid static electricity build up.

## **Battery Removal**

To remove the battery, follow the procedure below:

1. Open the seat.
2. Remove the tool kit.

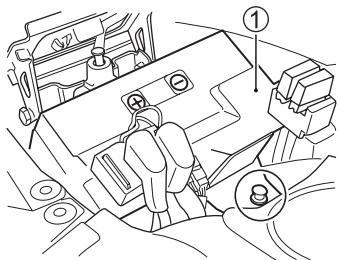

3. Remove the fastener. Remove the battery cover ①.

*NOTE: Do not remove the starter relay terminal.*

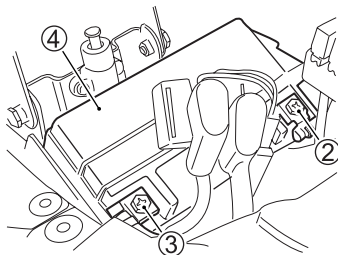

4. Disconnect the negative (-) terminal ②.
5. Remove the cap. Disconnect the positive (+) terminal ③.
6. Remove the battery ④.

To install the battery:

1. Install the battery in the reverse order of removal.
2. Connect the battery terminals securely.

## NOTICE

Reversing the battery lead wires can damage the charging system and the battery.

Always attach the red lead to the (+) positive terminal and the black (or black with white tracer) lead to the (-) negative terminal.

## ⚠ WARNING

Batteries contain toxic substances including sulfuric acid and lead. They could cause injury to humans or could damage the environment.

A used battery must be disposed of or recycled according to local law and must not be discarded with ordinary household waste. Make sure not to tip over the battery when you remove it from the vehicle. Otherwise, sulfuric acid could run out and you might be injured.

### NOTE:

- Select the same type MF battery when replacing the battery.
- Recharge the battery once a month if the motorcycle is not used for a long time.



The crossed-out wheeled bin symbol (A) located on the battery label indicates that a used battery should be collected separately from ordinary household waste. The chemical symbol of "Pb" (B) indicates the battery contains more than 0.004% lead.

By ensuring the used battery is disposed of or recycled correctly, you will help prevent potential negative consequences for the environment and human health, which could otherwise be caused by inappropriate waste handling of the battery. The recycling of materials will help to conserve natural resources. For more detailed information about disposing or recycling of the used battery, consult your Suzuki dealer.



## SPARK PLUG

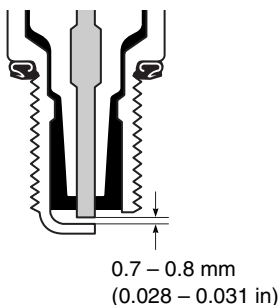

Remove the carbon deposits from the spark plug with a spark plug cleaning machine. Readjust the spark plug gap to 0.7 – 0.8 mm (0.028 – 0.031 in) by using a spark plug gap thickness gauge. The spark plug should be replaced periodically.

Whenever removing the carbon deposits, be sure to observe the operational color of the spark plug's porcelain tip. This color tells you whether or not the standard spark plug is suitable for your type of usage. A normally-operating spark plug should be light brown or tan color. If the spark plug is very white or glazed appearing, then it has been operating much too hot. This spark plug should be replaced with a colder plug.

## ***NOTICE***

An improper spark plug may have an incorrect fit or inappropriate heat range for your engine. This may cause severe engine damage which may not be covered under warranty.

Use one of the spark plugs listed or their equivalent. Consult your Suzuki dealer if you are not sure which spark plug is correct for your type of usage.

## Plug Replacement Guide

NGK	DENSO	REMARKS
CR7E	U22ESR-N	If the standard plug is wet in appearance or very dark in color, replace with this plug.
CR8E	U24ESR-N	Standard
CR9E	U27ESR-N	If the standard plug is very white or glazed in appearance replace with this plug.

*NOTE: This motorcycle uses a resistor-type spark plug to avoid jamming electronic parts. Improper spark plug selection may cause electronic interference with your motorcycle's ignition system, resulting in motorcycle performance problems. Use only the recommended spark plugs.*

To remove the spark plug, follow the procedure below:

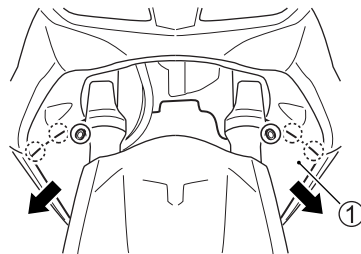
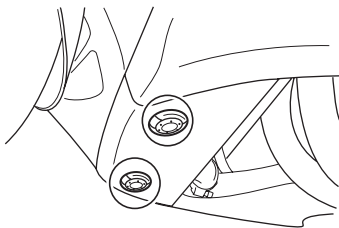

1. Remove the fasteners from the lower leg shield. Unhook the hooks and remove the lower leg shield forward ①.

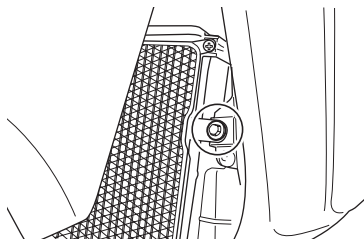

2. Remove the bolt. Pull the radiator forward.

### **▲ CAUTION**

A hot radiator and hot engine can burn you.

Wait until the radiator and engine are cool enough to touch with bare hands before starting this work.

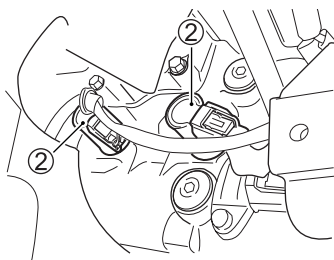

3. Release the coupler locks and disconnect the couplers from the ignition coils.
4. Pull off the ignition coils ②.
5. Remove the spark plug with a spark plug wrench.

## Installation

### **NOTICE**

Improper installation of the spark plug can damage your motorcycle. An overly-tight or cross-threaded spark plug will damage the aluminum threads of the cylinder head.

Carefully turn the spark plug by hand into the threads. If the spark plug is new, tighten it with a wrench about 1/2 turn past finger tight. If you are reusing the old spark plug, tighten it with a wrench about 1/8 turn past finger tight.

### **NOTICE**

Dirt can damage the moving engine parts of your motorcycle if it enters an open spark plug hole.

Cover the spark plug hole while the spark plug is out of the hole.

## AIR CLEANER

The air cleaner element must be kept clean to provide good engine power and gas mileage. If you use your motorcycle under normal low-stress conditions, you should service the air cleaner at the intervals specified. If you ride in dusty, wet, or muddy conditions, you will need to inspect the air cleaner element much more frequently. Use the following procedure to remove the element and inspect it.

### **WARNING**

Operating the engine without the air cleaner element in place can be hazardous. A flame can spit back from the engine to the air intake box without the air cleaner element to stop it. Severe engine damage can also occur if dirt enters the engine due to running the engine without the air cleaner element.

Never run the engine without the air cleaner element in place.

## ***NOTICE***

Failure to inspect the air cleaner element frequently if the vehicle is used in dusty, wet, or muddy conditions can damage your motorcycle. The air cleaner element can become clogged under these conditions, and engine damage may result.

Always inspect the air cleaner element after riding in severe conditions. Clean or replace the element as necessary. If water gets in the air cleaner case, immediately clean the element and the inside of the case.

Follow the procedure below to remove the air cleaner element.

1. Open the front trunk.

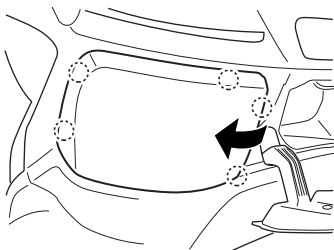

2. Remove the air cleaner maintenance lid.

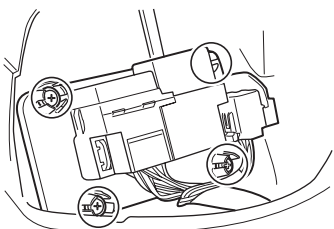

3. Remove the screws and air cleaner cap.

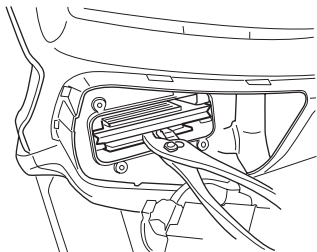

4. Pull out the air cleaner element with pliers.

## CLEANING THE ELEMENT

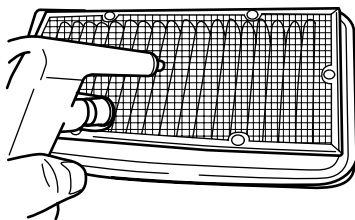

Carefully use an air hose to blow the dust from the air cleaner element.

*NOTE: Always apply air pressure to the mesh side of the air cleaner element only. If you apply air pressure to the fabric side, dirt will be forced into the pores of the element, restricting the air flow through the element.*

### **NOTICE**

**A torn air cleaner element will allow dirt to enter the engine and can damage the engine.**

**Replace the air cleaner element with a new one if it is torn. Carefully examine the air cleaner element for tears during cleaning.**

## NOTICE

Failure to position the air cleaner element properly can allow dirt to bypass the air cleaner element. This will cause engine damage.

Be sure to properly install the air cleaner element.

*NOTE: Be careful not to spray water on the air cleaner box when cleaning the motorcycle.*

## AIR CLEANER DRAIN TUBES

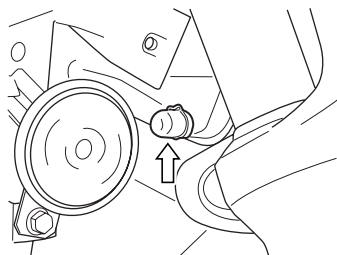
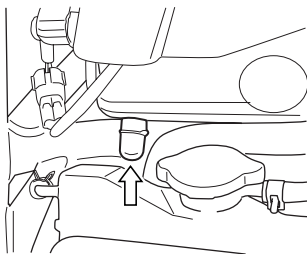

Remove the plugs and drain water and oil at the periodic maintenance interval.

## ENGINE IDLE SPEED INSPECTION

Inspect the engine idle speed. The engine idle speed should be 1100 – 1300 r/min when the engine is warm.

*NOTE: If the engine idle speed is not within the specified range, ask your Suzuki dealer or a qualified mechanic to inspect and repair the motorcycle.*

## THROTTLE CABLE PLAY

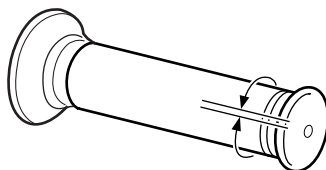
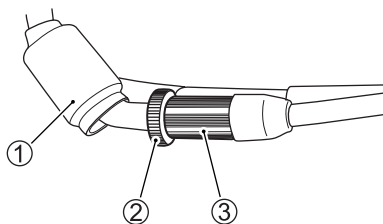

2.0 – 4.0 mm  
(0.08 – 0.16 in)

To adjust the cable play:

1. Remove the boot ①.
2. Loosen the lock nut ②.
3. Turn the adjuster ③ so that the throttle grip has 2.0 – 4.0 mm (0.08 – 0.16 in) play.
4. Tighten the lock nut ②.
5. Reinstall the boot ①.

### **WARNING**

Inadequate throttle cable play can cause engine speed to rise suddenly when you turn the handlebars. This can lead to loss of control and an accident.

Adjust the throttle cable play so that engine idle speed does not rise due to handlebar movement.

## Throttle Cable Boots

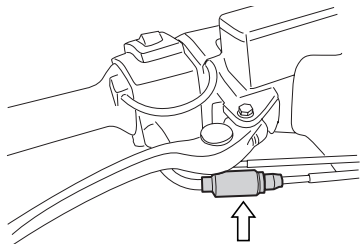

The throttle cable has boots. Check that the boots are fit securely. Do not apply water directly to the boots when washing. Wipe off dirt from the boots with a wet cloth when the boots are dirty.

## CVT FILTER

### Right Side Leg Shield Removal

1. Remove the lower leg shield by referring to the SPARK PLUG section.
2. Remove the floor mats.

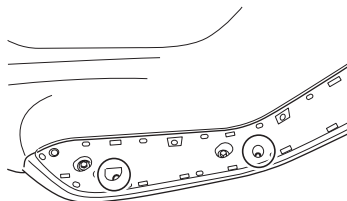
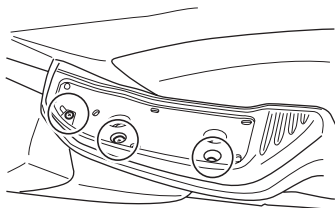

3. Remove the screws.



## CVT Filter Replacement

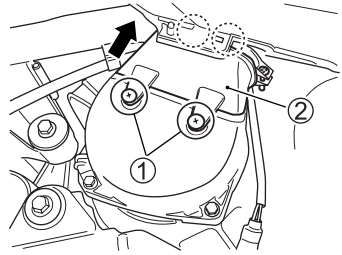
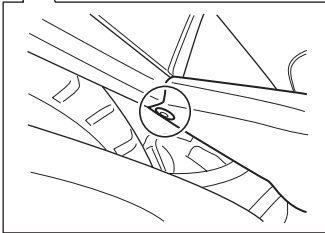
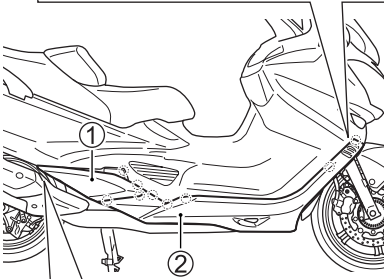
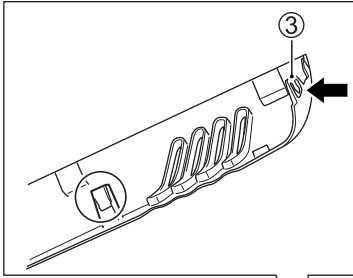

1. Remove the screws ①.
2. Unhook the hooks and move the CVT filter lid ②.

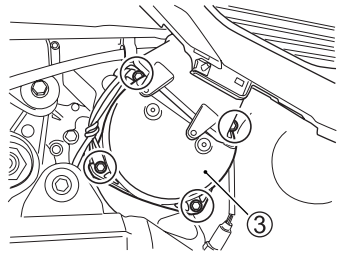

3. Remove the bolts and CVT filter cover ③.

4. Remove the fastener.
5. Unhook the hooks and remove the right side rear lower foot-board ①.
6. Unhook the hooks and remove the right side leg shield ②.

**NOTE:** To remove the right side leg shield ②, push the hook ③ located inside the front side of leg shield and pull it towards you.

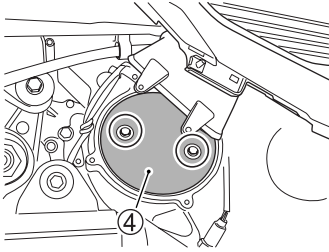

4. Remove the bolts and CVT filter ④.

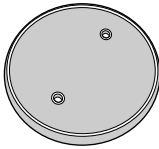

5. Inspect the CVT filter for damage and dirt. If any defects are found, the CVT filter must be replaced.

## ENGINE COOLANT

### Coolant Level

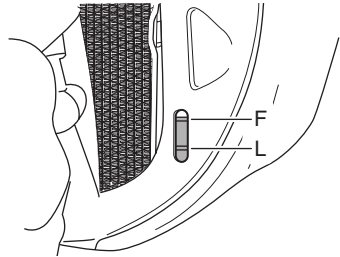

The coolant should be kept between the “F” (FULL) and the “L” (LOW) level lines in the reservoir tank at all times. Inspect the level every time before riding with the motorcycle held vertically. If the coolant is found lower than the “L” level line, add specified engine coolant through the filler hole until it reaches the “F” line.

#### NOTE:

- Check the coolant level when the engine is cold.
- If the engine coolant reservoir is empty, check the radiator coolant level.

To add specified engine coolant:

1. Place the motorcycle on the center stand.

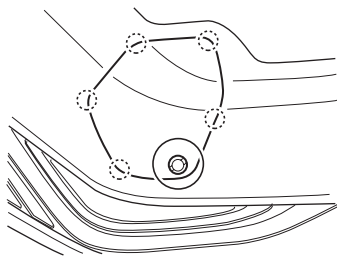

2. Remove the fastener. Unhook the hooks and remove the maintenance lid.

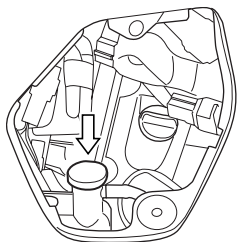

3. Remove the filler cap and add specified engine coolant through the filler hole until it reaches the "F" line. Refer to the FUEL, ENGINE OIL AND COOLANT RECOMMENDATIONS section.

## **WARNING**

Engine coolant is harmful or fatal if swallowed or inhaled. Solution can be poisonous to animals.

Do not drink antifreeze or coolant solution. If swallowed, do not induce vomiting. Immediately contact a poison control center or a physician. Avoid inhaling mist or hot vapors; if inhaled, remove to fresh air. If coolant gets in eyes, flush eyes with water and seek medical attention. Wash thoroughly after handling. Keep out of the reach of children and animals.

*NOTE: Adding only water will dilute the engine coolant and reduce its effectiveness. Add specified engine coolant.*

### **Changing The Coolant**

Change the coolant periodically.

*NOTE: About 1600 ml (1.7 US qt) of coolant will be required when filling the radiator and reservoir tank.*

### **Radiator Hose Inspection**

Inspect the radiator hoses for cracks, damage or engine coolant leakage. If any defects are found, ask your Suzuki dealer to replace the radiator hose with a new one.

## ENGINE OIL

Long engine life depends much on the selection of a quality oil and the periodic changing of the oil. Daily oil level checks and periodic changes are two of the most important maintenance items to be performed.

### Engine Oil Level Check

Follow the procedure below to inspect the engine oil level.

1. Place the motorcycle on the center stand.
2. Start the engine and run it for three minutes.
3. Stop the engine and wait three minutes.

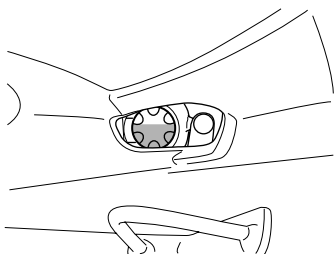

4. Hold the motorcycle vertically and inspect the engine oil level through the engine oil level inspection window on the left side of the engine.

## NOTICE

Operating the motorcycle with too little or too much oil can damage the engine.

Place the motorcycle on level ground. Check the oil level with the engine oil inspection window before each use of the vehicle. Be sure the engine oil level is always above the "L" (low) line and not higher than the "F" (full) line.

## Engine Oil and Filter Change

Change the engine oil and oil filter at the scheduled time. The oil should be changed when the engine is warm so that the oil will drain thoroughly from the engine. The procedure is as follows:

1. Place the motorcycle on the center stand. Remove the maintenance lid.

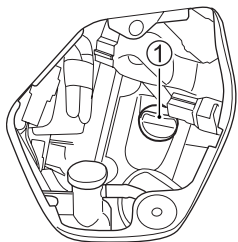

2. Remove the oil filler cap ①.

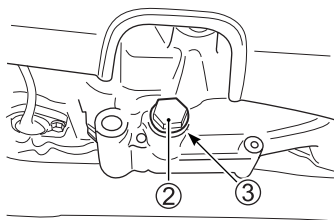

3. Remove the drain plug ② and gasket ③ from the bottom of the engine and drain the engine oil into a drain pan.

### ▲ CAUTION

Hot engine oil and exhaust pipes can burn you.

Wait until the engine oil drain plug and exhaust pipes cool before draining oil.

### ▲ CAUTION

A hot muffler can burn you. The muffler will be hot enough to burn you for some time after stopping the engine.

Wait until the muffler cools to avoid burns.

## **⚠ WARNING**

Children and pets may be harmed by swallowing new or used oil. Repeated, prolonged contact with used engine oil may cause skin cancer. Brief contact with oil may irritate skin.

Keep new and used oil and used oil filters away from children and pets. To minimize your exposure to used oil, wear a long-sleeve shirt and moisture-proof gloves (such as dishwashing gloves) when changing oil. If oil contacts your skin, wash thoroughly with soap and water. Launder any clothing or rags if wet with oil. Recycle or properly dispose of used oil and filters.

## **NOTICE**

Turning the engine while draining the engine oil will cause oil film shortage and adversely affect the engine.

Do not use the electric starter switch during engine oil replacement work.

## **NOTE:**

- *Recycle or properly dispose of used oil.*
- *Before starting the work, check that there is not any dust, mud, or foreign object inside the oil jug or on the oil filter mounting surface.*

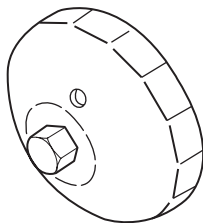

Available from Suzuki dealer  
Oil filter wrench  
(Part No. 09915-40620)

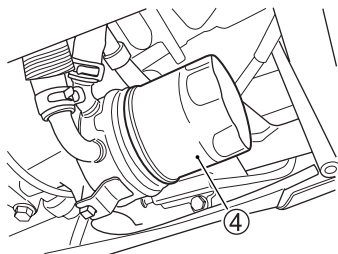

4. Turn the oil filter ④ counter-clockwise and remove it with a Suzuki “cap type” oil filter wrench or a “strap type” filter wrench of the proper size.
5. Wipe off the mounting surface on the engine where the new filter will be seated with a clean rag.

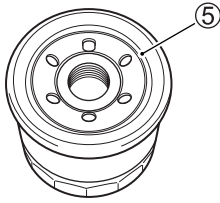

6. Smear a little engine oil around the rubber gasket ⑤ of the new oil filter.

### **NOTICE**

**Failure to use an oil filter with the correct design and thread specifications can damage your motorcycle's engine.**

**Be sure to use a genuine Suzuki oil filter or an equivalent one designed for your motorcycle.**

7. Screw the new filter by hand until the filter gasket contacts the mounting surface (a small resistance will be felt).

*NOTE: To tighten the oil filter properly, it is important to accurately identify the position at which the filter gasket first contacts the mounting surface.*

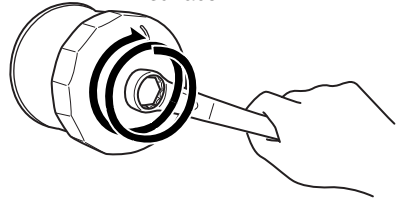
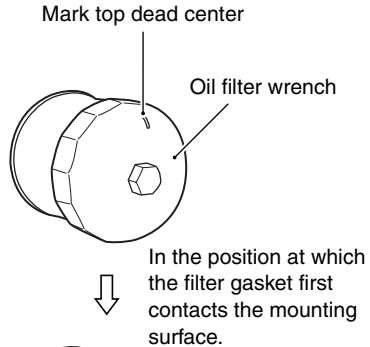

Tighten the filter 2 turns or to specified torque.

8. Mark the top dead center position on the "cap type" filter wrench or on the oil filter. Use an oil filter wrench to tighten the filter 2 turns or to specified torque.

Oil filter tightening torque:  
20 N·m (2.0 kgf-m, 14.5 lbf-ft)

9. Replace the drain plug gasket ③ with a new one. Reinstall the drain plug ② and gasket ③. Tighten the plug securely with a torque wrench. Pour 2900 ml (3.1 US qt) of new oil through the filler hole and install the filler cap. Be sure to always use the specified engine oil described in the FUEL, ENGINE OIL AND COOLANT RECOMMENDATIONS section.
10. Start the engine (while the motorcycle is outside on level ground) and allow it to idle for three minutes.
11. Turn the engine off and wait approximately three minutes. Recheck the oil level on the engine oil inspection window while holding the motorcycle vertically. If it is lower than the "L" line, add oil until the oil level is between the "L" line and the "F" line. Inspect the area around the drain plug and oil filter for leaks.

Drain plug tightening torque:  
23 N·m (2.3 kgf-m, 16.5 lbf-ft)

*NOTE: About 2600 ml (2.7 US qt) of oil will be required when changing oil only.*

*NOTE: If you do not have a proper oil filter wrench, have your Suzuki dealer perform this service.*

## **NOTICE**

**Engine damage may occur if you use oil that does not meet Suzuki's specifications.**

**Be sure to use the oil specified in the FUEL, ENGINE OIL AND COOLANT RECOMMENDATIONS section.**



## TRANSMISSION OIL AND FINAL GEAR OIL

### Left Side Leg Shield Removal

1. Remove the lower leg shield by referring to the SPARK PLUG section.
2. Remove the floor mats.

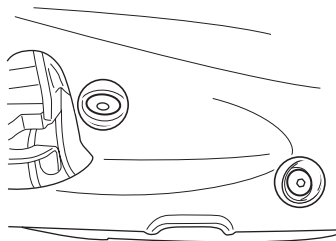
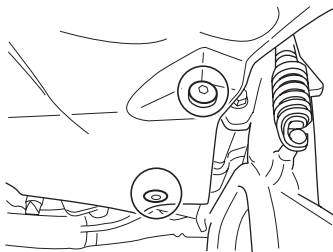
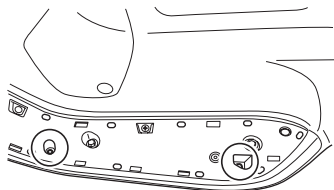
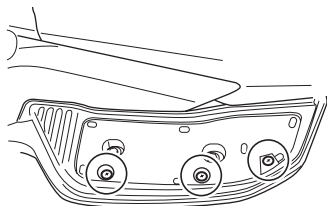

3. Remove the screws.

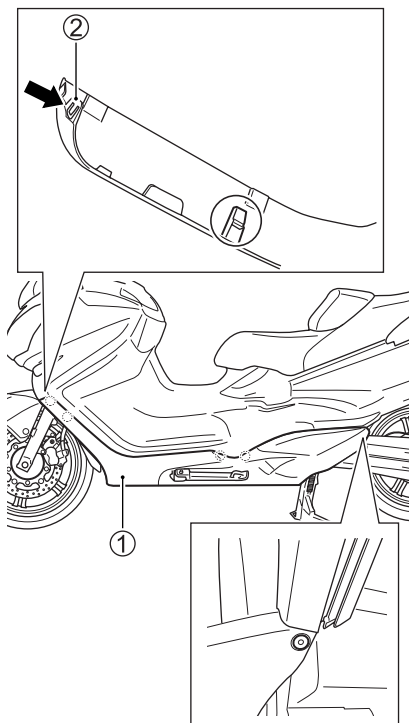

4. Remove the bolts and fasteners.
5. Unhook the hooks and remove the left side lower footboard, under cover and left side leg shield (1).

**NOTE:** To remove the left side leg shield (1), push the hook (2) located inside the front side of leg shield and pull it towards you.

## Transmission Oil Replacement

1. Place the motorcycle on level ground on the center stand. Hold the motorcycle vertically and check the transmission oil.

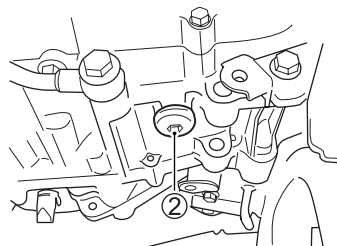
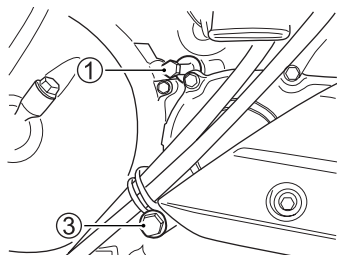

2. Remove the oil filler plug (1).
3. Remove the drain plug (2) from the bottom of the engine and drain the transmission oil into a drain pan.
4. Reinstall the drain plug (2). Tighten the plug securely with a wrench.
5. Remove the oil level plug (3) and inspect the oil level. If the level is below the level hole, add oil until oil flows from the level hole.
6. Tighten the oil level plug (3) and oil filler plug (1).

## Final Gear Oil Replacement

1. Place the motorcycle on level ground on the center stand. Hold the motorcycle vertically and check the final gear oil.

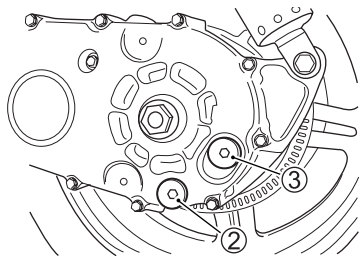
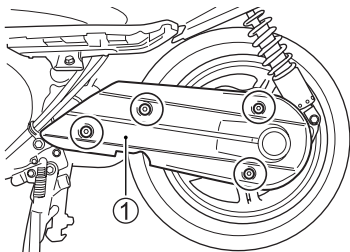

2. Remove the bolts and final gear case cover ①.
3. Place an oil pan below the final gear case.
4. Remove the oil drain plug ② and oil level plug ③.
5. Tighten the oil drain plug ② and pour fresh oil through the oil level hole until the oil level reaches the oil level hole.
6. Tighten the oil level plug ③.

## ⚠ WARNING

Operating the motorcycle with too little final gear oil can cause the final drive unit to lock up and cause an accident.

Check for leaks and the correct level of final gear oil before each use. Add oil if necessary. Tighten the drain plug securely after changing the gear oil.

## ⚠ WARNING

Children and pets may be harmed by swallowing new or used oil. Repeated, prolonged contact with used engine oil may cause skin cancer. Brief contact with oil may irritate skin.

Keep new and used oil away from children and pets. To minimize your exposure to used oil, wear a long-sleeve shirt and moisture-proof gloves (such as dishwashing gloves) when changing oil. If oil contacts your skin, wash thoroughly with soap and water. Launder any clothing or rags if wet with oil. Recycle or properly dispose of used oil.

*NOTE: Recycle or properly dispose of used oil.*

## **BRAKES**

This motorcycle utilizes front and rear disk brakes. Proper operation of brake systems are vital to safe riding. Be sure to perform the brake inspection as scheduled.

### **Brake System**

#### **WARNING**

**Failure to properly inspect and maintain your motorcycle's brake systems can increase your chance of having an accident.**

**Be sure to inspect the brakes before each use according to the INSPECTION BEFORE RIDING section. Always maintain your brakes according to the MAINTENANCE SCHEDULE.**

Inspect your brake system for the following items daily:

- Inspect the fluid level in the reservoirs.
- Inspect the front and rear brake system for signs of fluid leakage.
- Inspect the brake hose for leakage or a cracked appearance.
- The brake levers should have the proper stroke and be firm at all times.
- Check the wear of the disk brake pads.

#### **Brake Hose Inspection**

Inspect the brake hoses and hose joints for cracks, damage or brake fluid leakage. If any defects are found, ask your Suzuki dealer to replace the brake hose with a new one.

## Brake Fluid

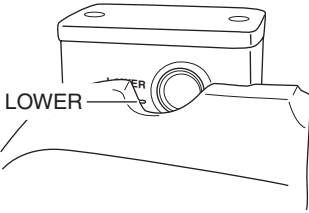

FRONT

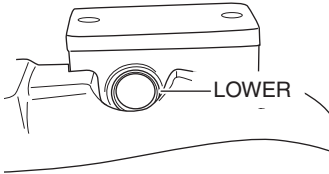

REAR

Check the brake fluid level in both the front and rear brake fluid reservoirs. If the level in either reservoir is below the lower mark, inspect for brake pad wear and leaks.

### **WARNING**

Brake fluid will gradually absorb moisture through the brake hoses. Brake fluid with high water content lowers the boiling point and can cause brake system (including ABS) malfunction due to corrosion of brake components. Boiling brake fluid or brake system (including ABS) malfunction could result in an accident.

Replace the brake fluid every two years to maintain braking performance.

### **WARNING**

The use of any fluid except DOT4 brake fluid from a sealed container can damage the brake system and lead to an accident.

Clean filler cap before removing. Use only DOT4 brake fluid from a sealed container. Never use or mix with different types of brake fluid.

## **⚠ WARNING**

Brake fluid is harmful or fatal if swallowed, and harmful if it comes in contact with skin or eyes. Solution can be poisonous to animals.

If brake fluid is swallowed, do not induce vomiting. Immediately contact a poison control center or a physician. If brake fluid gets in eyes, flush eyes with water and seek medical attention. Wash thoroughly after handling. Keep out of the reach of children and animals.

## **NOTICE**

Spilled brake fluid can damage painted surfaces and plastic parts.

Be careful not to spill any fluid when filling the brake fluid reservoir. Wipe spilled fluid up immediately.

*NOTE: SUZUKI highly recommends the use of ECSTAR brand brake fluid. ECSTAR has been specially formulated for your SUZUKI product and contributes to the desired motorcycle performance and ideal riding experience.*

## Brake Pad

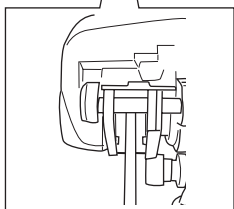
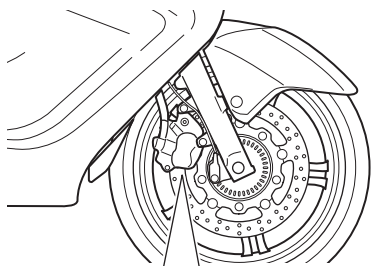

FRONT

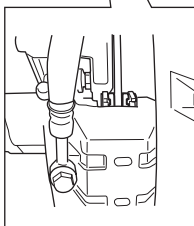
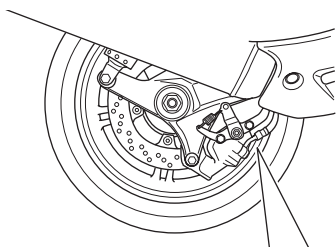

REAR

Grooved wear limit line

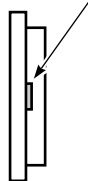

Inspect the front and rear brake pads by noting whether or not the friction pads are worn down to the grooved wear limit line. If a front or rear pad is worn to the grooved wear limit line, both front or both rear pads must be replaced with new ones by your authorized Suzuki dealer or a qualified service mechanic.

### **⚠ WARNING**

**Failure to inspect and maintain the brake pads and replace them when recommended can increase your chance of having an accident.**

**If you need to replace brake pads, have your Suzuki dealer do this work. Inspect and maintain the brake pads as recommended.**

## **WARNING**

If you ride this motorcycle after brake system repair or brake pad replacement without pumping the brake lever, you may get poor braking performance which could result in an accident.

After brake system repair or brake pad replacement, pump the brake lever several times until brake pads are pressed against the brake disks and proper lever stroke and firm feel are restored.

*NOTE: Do not squeeze the brake lever when the pads are not in their positions. It is difficult to push the pistons back and brake fluid leakage may result.*

## **WARNING**

Replacing only one of the two brake pads can result in uneven braking action and can increase your chance of having an accident.

Always replace both pads together.

## **TIRES**

## **WARNING**

The tires on your motorcycle form the crucial link between your motorcycle and the road. Failure to take the precautions below may result in an accident due to tire failure.

- Check tire condition and pressure before each ride, and adjust pressure if necessary.
- Avoid overloading your motorcycle.
- Replace a tire when worn to the specified limit, or if you find damage such as cuts or cracks.
- Always use the size and type of tires specified in this owner's manual.
- Balance the wheel after tire installation.
- Read this section of the owner's manual carefully.



## **WARNING**

Failure to perform break-in of the tires could cause tire slip and loss of control, which could result in an accident.

Use extra care when riding on new tires. Perform proper break-in of the tires referring to the **BREAK-IN** section of this manual and avoid hard acceleration, hard cornering, and hard braking for the first 100 miles (160 km).

## **TIRE PRESSURE**

Insufficient air pressure in the tires not only hastens tire wear but also seriously affects the stability of the motorcycle. Under inflated tires make smooth cornering difficult and overinflated tires decrease the amount of tire in contact with the ground which can lead to skids and loss of control. Be sure that the tire pressure is within the specified limits at all times. Tire pressure should only be adjusted when the tires are cold.

### **Cold Inflation Tire Pressure**

<b>LOAD</b> <b>TIRE</b>	<b>SOLO RIDING</b>	<b>DUAL RIDING</b>
<b>FRONT</b>	225 kPa 2.25 kgf/cm <sup>2</sup> 33 psi	225 kPa 2.25 kgf/cm <sup>2</sup> 33 psi
<b>REAR</b>	280 kPa 2.80 kgf/cm <sup>2</sup> 41 psi	280 kPa 2.80 kgf/cm <sup>2</sup> 41 psi

## TIRE TREAD CONDITION

Tire condition and tire type affect vehicle performance. Cuts or cracks in the tires can lead to tire failure and loss of vehicle control. Worn tires are susceptible to puncture failures and subsequent loss of vehicle control. Tire wear also affects the tire profile, changing vehicle handling characteristics.

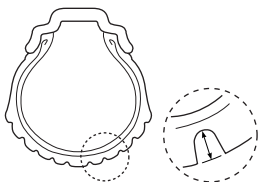

Check the condition of your tires each day before you ride. Replace tires if tires show visual evidence of damage, such as cracks or cuts, or if tread depth is less than 1.6 mm (0.06 in) front, 2.0 mm (0.08 in) rear.

*NOTE: These wear limits will be reached before the wear bars molded into the tire make contact with the road.*

When you replace a tire, be sure to replace it with a tire of the size listed below. If you use a different size of tire, motorcycle handling may be adversely affected, possibly resulting in loss of motorcycle control.

	FRONT	REAR
SIZE	120/70R15M/C 56H	160/60R14M/C 65H
TYPE	BRIDGESTONE TH01F	BRIDGESTONE TH01R M

Be sure to balance the wheel after repairing a puncture or replacing the tire. Proper wheel balance is important to avoid variable wheel-to-road contact, and to avoid uneven tire wear.

## **▲ WARNING**

**An improperly repaired, installed, or balanced tire can cause loss of control and an accident, or can wear out sooner.**

- **Ask your Suzuki dealer or a qualified mechanic to perform tire repair, replacement, and balancing because proper tools and experience are required.**
- **Install tires according to the rotation direction shown by arrows on the sidewall of each tire.**

## **⚠ WARNING**

Failure to follow the instructions below for tubeless tires may result in an accident due to tire failure. Tubeless tires require different service procedures than tube tires.

- Tubeless tires require an airtight seal between the tire bead and wheel rim. Special tire irons and rim protectors or a specialized tire mounting machine must be used for removing and installing tires to prevent tire or rim damage which could result in an air leak.
- Repair punctures in tubeless tires by removing the tire and applying an internal patch.
- Do not use an external repair plug to repair a puncture since the plug may work loose as a result of the cornering forces experienced by a motorcycle tire.
- After repairing a tire, do not exceed 80 km/h (50 mph) for the first 24 hours, and do not exceed 130 km/h (80 mph) thereafter. This is to avoid excessive heat build-up which could result in a tire repair failure and tire deflation.
- Replace the tire if it is punctured in the sidewall area, or if a puncture in the tread area is larger than 6 mm (3/16 in). These punctures cannot be repaired adequately.

## **SIDE STAND/IGNITION INTERLOCK SYSTEM**

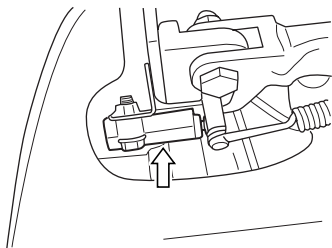

Check the side stand/ignition interlock system for proper operation as follows:

1. Sit on the motorcycle in the normal riding position, with the side stand up.
2. Squeeze the front or rear brake lever and start the engine.
3. While continuing to hold the brake lever, move the side stand to the down position.

If the engine stops running when the side stand is moved to the down position, then the side stand/ignition interlock system is working properly. If the engine continues to run with the side stand down, then the side stand/ignition interlock system is not working properly. Have your motorcycle inspected by an authorized Suzuki dealer or a qualified service mechanic.

## **⚠ WARNING**

If the side stand/ignition interlock system is not working properly, it is possible to ride the motorcycle with the side stand in the down position. This may interfere with rider control during a left turn and could cause an accident.

Check the side stand/ignition interlock system for proper operation before riding. Check that the side stand is returned to its full up position before starting off.

## **LIGHT BULB REPLACEMENT**

The wattage rating of each bulb is shown on the chart below. When replacing a burned out bulb, always use the exact same wattage rating. Using other than the specified rating can result in overloading the electrical system or premature failure of a bulb.

### ***NOTICE***

**Failure to use a light bulb with the correct wattage rating can overload the electrical system of your motorcycle or cause the bulb to burn out sooner.**

**Use only the light bulbs shown in the chart as replacement bulbs.**

Headlight	12V 60/55W (H4) × 2
Front turn signal light	12V 21W × 2
Rear turn signal light	12V 21W × 2
Brake light/Taillight	12V 21/5W × 2
License plate light	12V 5W

## HEADLIGHT BULB REPLACEMENT

To replace the headlight bulb, follow the procedure below:

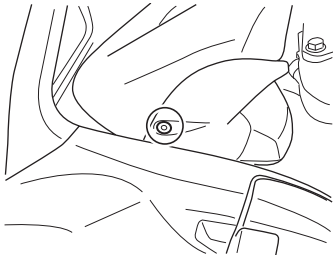
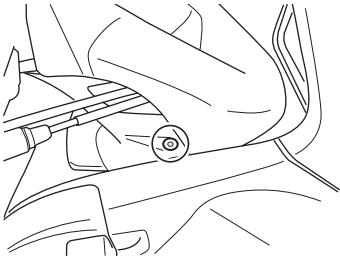

1. Remove the right and left fasteners.

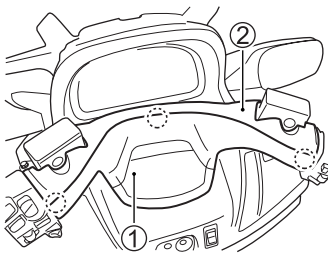

2. Unhook the hooks and remove the rear handle cover ①.
3. Remove the front handle cover ②.

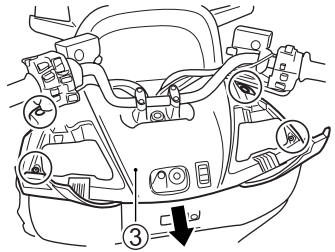

4. Open the right and left front small box. Remove the screws and fasteners. Unhook the hooks. Pull the front panel ③ backward and remove it.

*NOTE: It is not necessary to disconnect the seat heater switch coupler.*

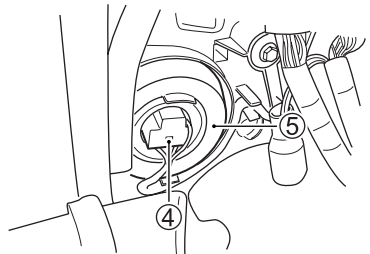

5. Disconnect the socket ④ from the headlight.
6. Remove the rubber cap ⑤.

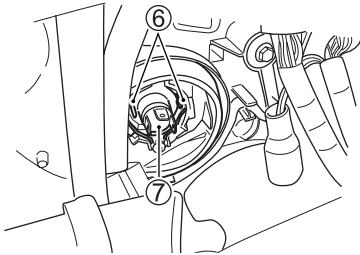

7. Unhook the bulb holder spring (6) and pull out the bulb socket (7).
8. Fit the new bulb.
9. To reinstall the headlight, reverse the sequence described above.

## **NOTICE**

The headlight bulb's life may be shortened by oil from your fingers if you touch it.

When replacing the headlight bulb, be careful not to touch the glass. Grasp the new bulb with a clean cloth.

## **Headlight Beam Adjustment**

The headlight beam can be adjusted both up and down or right and left if necessary.

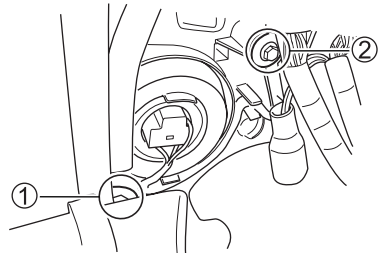

### **To adjust the beam up and down:**

Turn the adjuster (1) clockwise or counterclockwise.

### **To adjust the beam right and left:**

Turn the adjuster (2) clockwise or counterclockwise.

## FRONT TURN SIGNAL LIGHT BULB REPLACEMENT

To replace the front turn signal light bulb, follow the procedure below:

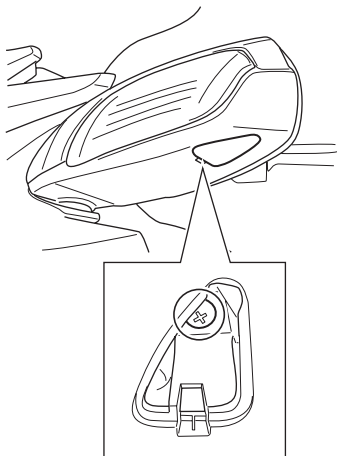

1. Remove the cap.
2. Remove the screw and take off the front turn signal assembly.

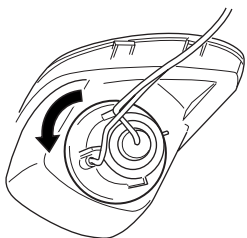

3. Turn the socket counterclockwise and remove it.
4. Push in on the bulb, twisting it to the left, and pull it out.

## BRAKE LIGHT/TAILLIGHT, REAR TURN SIGNAL LIGHT AND LICENSE PLATE LIGHT BULB REPLACEMENT

To replace the brake light/taillight bulb, rear turn signal light bulb and license plate light bulb, follow the procedure below:

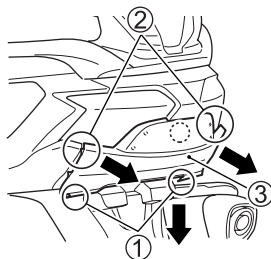

1. Remove the fasteners ①. Unhook the hooks ②. Pull the under frame cover ③ backward and remove it.

## Brake Light/Taillight/ Rear Turn Signal Light

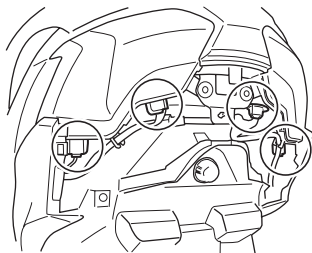

2. Turn the socket counterclockwise and remove the socket.

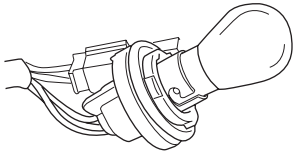

Brake light/Taillight bulb

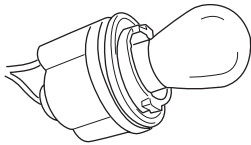

Rear turn signal light bulb

3. Turn the socket counterclockwise and remove the socket.
4. Push in on the burned-out bulb, turn it to the left, and pull it out.
5. To fit the replacement bulb, push it in and turn it to the right while pushing.

## License Plate Light



2. Turn the license plate lens counterclockwise and remove it.

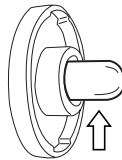

3. Pull off the bulb from the socket.



## FUSES

If something electrical on your motorcycle stops working, the first thing you should check for is a blown fuse. The electrical circuits on the motorcycle are protected from overload by fuses in the circuits.

If a blown fuse is found, then the electrical problem must be inspected and repaired before replacing the blown fuse with a new fuse. Consult your Suzuki dealer for the electrical system check and repair.

### WARNING

Replacing a fuse with a fuse that has an incorrect amperage rating or substitute, e.g. aluminum foil or wire, may cause serious damage to the electrical system and possibly fire. Always replace a blown fuse with a fuse of the same amperage rating.

If the new fuse blows in a short time, the electrical problem may not be fixed. Have your motorcycle inspected immediately by your Suzuki dealer.

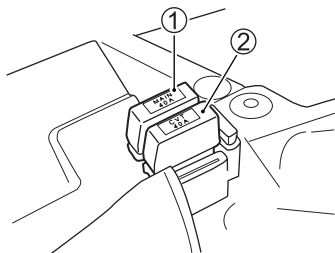

The fuses ① and ② are located under the seat.

40A MAIN fuse ① protects all electrical circuits.

40A CVT fuse ② protects CVT circuits.

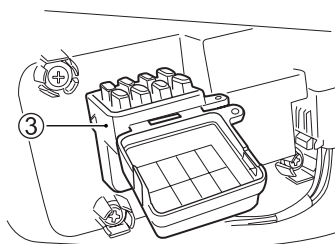

Fuse box ③ is located under the air cleaner maintenance lid. To access the fuse box, remove the lid by referring to the AIR CLEANER section.

Fuse box ③ has HEAD-HI, HEAD-LO, FUEL, ABS-V, ABS-M and FAN fuses.

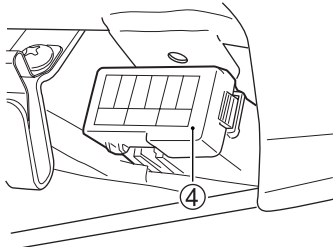

Fuse box ④ is located under the seat.

Fuse box ④ has MIRROR, OUTLET, SCREEN, S-HEATER, IGNITION and SIGNAL fuses.

- 15A HEAD-HI fuse protects the headlight high beam and high beam indicator light.
- 15A HEAD-LO fuse protects the headlight low beam.
- 10A FUEL fuse protects the fuel pump, fuel injector, trunk box light and ECM.
- 10A IGNITION fuse protects the ignition coil, ECM, oxygen sensor, starter relay, side stand relay, fuel pump relay and canister purge solenoid (California).
- 15A SIGNAL fuse protects the horn, turn signal lights, stop light, taillight, cooling fan relay, solenoid, speedometer, ECM and position light.
- 15A FAN fuse protects the cooling fan motor.
- 15A OUTLET fuse protects the output terminal and grip heater.
- 15A ABS-V fuse protects the ABS controller.
- 20A ABS-M fuse protects the ABS controller.
- 3A MIRROR fuse protects the mirror motor.
- 20A SCREEN fuse protects the screen relay and screen.
- 5A SEAT HEATER fuse protects the seat heater.

## CATALYTIC CONVERTER

The purpose of the catalytic converter is to minimize the amount of harmful pollutants in your motorcycle's exhaust. Use of leaded fuel in motorcycles equipped with catalytic converters is prohibited because lead deactivates the pollutant-reducing components of the catalyst system.

The converter is designed to last the life of the motorcycle under normal usage and when unleaded fuel is used. Not special maintenance is required on the converter. However, it is very important to keep the engine properly tuned. Engine misfiring, which can result from an improperly tuned engine, may cause overheating of the catalyst. This may result in permanent heat damage to the catalyst and other motorcycle components.

## ***NOTICE***

**Improper motorcycle operation can cause catalyst or other motorcycle damage.**

**To avoid damage to the catalyst or other related components, you should take the following precautions:**

- **Maintain the engine in the proper operating condition.**
- **In the event of an engine malfunction, particularly one involving engine misfire or other apparent performance loss, stop riding the motorcycle and turn off the engine and have the motorcycle serviced promptly.**
- **Do not shut off the engine or interrupt the ignition when the transmission is in gear and the motorcycle is in motion.**
- **Do not try to start the engine by pushing the motorcycle or by coasting down a hill.**
- **Do not idle the engine with any spark plug wires disconnected or removed, such as during diagnostic testing.**
- **Do not idle the vehicle for prolonged periods if idling seems rough or there are other malfunctions.**
- **Do not allow the fuel tank to get near the empty level.**

## **⚠ WARNING**

If you park or operate the motorcycle in areas where there are combustible materials such as dry grass or leaves, these materials may come in contact with the catalytic converter or other hot exhaust components. This can cause a fire.

Avoid parking or operating your vehicle in areas with any combustible materials.





# TROUBLESHOOTING

---

IGNITION SYSTEM CHECK ..... 8-2

## TROUBLESHOOTING

This troubleshooting guide is provided to help you find the cause of some common complaints.

### **NOTICE**

**Improper repairs or adjustments may damage the motorcycle instead of fixing it. Such damage may not be covered under warranty.**

**If you are not sure about the proper action, consult your Suzuki dealer about the problem.**

## IGNITION SYSTEM CHECK

1. Remove the spark plugs and reattach them to the spark plug leads.
2. While holding a spark plug firmly against the engine, crank the engine with the ignition switch in the "ON" position. If the ignition system is operating properly, a blue spark should jump across the spark plug gap. If there is no spark, consult your Suzuki dealer for repairs.

### **WARNING**

**Performing the spark test improperly can be hazardous. You could get a high voltage electrical shock if you are not familiar with this procedure.**

**Do not perform this check if you are not familiar with the procedure. Do not point the spark plug near the spark plug hole during this test. Do not perform this test if you have a heart condition or wear a pacer-maker.**

## ENGINE STALLING

1. Check the fuel supply in the fuel tank.
2. Check the ignition system for intermittent spark.
3. Check the idle speed.

# STORAGE PROCEDURE AND MOTORCYCLE CLEANING

---

STORAGE PROCEDURE .....	9-2
PROCEDURE FOR RETURNING TO SERVICE .....	9-3
CORROSION PREVENTION .....	9-3
MOTORCYCLE CLEANING .....	9-4
INSPECTION AFTER CLEANING .....	9-7



# STORAGE PROCEDURE AND MOTORCYCLE CLEANING

## STORAGE PROCEDURE

If the motorcycle is to be left unused for an extended period of time for winter storage or any other reason, the machine needs special servicing requiring appropriate materials, equipment and skill. For this reason, Suzuki recommends that you trust this maintenance work to your Suzuki dealer. If you need to service the machine for storage yourself, follow the general guidelines below.

### MOTORCYCLE

Clean the entire motorcycle. Place the motorcycle on the center stand on a firm, flat surface where it will not fall over. Turn the handlebars all the way to the left and lock the steering, and remove the ignition key.

### FUEL

Fill the fuel tank to the top with fuel mixed with the amount of gasoline stabilizer recommended by the stabilizer manufacturer.

## BATTERY

1. Remove the battery from the motorcycle by referring to the BATTERY section.
2. Clean the outside of the battery with a mild detergent and remove any corrosion from the terminals and wiring harness connections.
3. Store the battery in a room above freezing.

## TIRES

Inflate the tires to the normal specifications.

## EXTERNAL

- Spray all vinyl and rubber parts with rubber preservative.
- Spray the unpainted surfaces with rust preventative.
- Coat the painted surfaces with car wax.

## PROCEDURE DURING STORAGE

Once a month, recharge the battery with a specified charging rate (Ampere). Standard charging rate is  $1.4A \times 5$  to 10 hours.

## PROCEDURE FOR RETURNING TO SERVICE

- Clean the entire motorcycle.
- Reinstall the battery by referring to the BATTERY section.
- Adjust the pressure of tires as described in the TIRE section.
- Lubricate all places as instructed in this manual.
- Do the “INSPECTION BEFORE RIDING” as listed in this manual.

## CORROSION PREVENTION

It is important to take good care of your motorcycle to protect it from corrosion and keep it looking new for years to come.

### Important Information About Corrosion

Common causes of corrosion

- Accumulation of road salt, dirt, moisture, or chemicals in hard-to-reach areas.
- Chipping, scratches, and any damage to treated or painted metal surfaces resulting from minor accidents or impacts from stones and gravel.

Road salt, sea air, industrial pollution, and high humidity will all contribute to corrosion.

### How to Help Prevent Corrosion

- Wash your motorcycle frequently, at least once a month. Keep your motorcycle as clean and dry as possible.
- Remove foreign material deposits. Foreign material such as road salt, chemicals, road oil or tar, tree sap, bird droppings and industrial fallout may damage your motorcycle's finish. Remove these types of deposits as quickly as possible. If these deposits are difficult to wash off, an additional cleaner may be required. Follow the manufacturer's directions when using these special cleaners.

- Repair finish damage as soon as possible. Carefully examine your motorcycle for damage to the painted surfaces. Should you find any chips or scratches in the paint, touch them up immediately to prevent corrosion from starting. If the chips or scratches have gone through to the bare metal, have a Suzuki dealer make the repair.
- Store your motorcycle in a dry, well-ventilated area. If you often wash your motorcycle in the garage or if you frequently park it inside when wet, your garage may be damp. The high humidity may cause or accelerate corrosion. A wet motorcycle may corrode even in a heated garage if the ventilation is poor.
- Cover your motorcycle. Exposure to mid-day sun can cause the colors in paint, plastic parts, and instrument faces to fade. Covering your motorcycle with a high-quality, “breathable” motorcycle cover can help protect the finish from the harmful UV rays in sunlight, and can reduce the amount of dust and air pollution reaching the surface. Your Suzuki dealer can help you select the right cover for your motorcycle.

## MOTORCYCLE CLEANING

### WASHING THE MOTORCYCLE

When washing the motorcycle, follow the instructions below:

1. Remove dirt and mud from the motorcycle with cool running water. You may use a soft sponge or brush. Do not use hard materials which can scratch the paint.
2. Wash the entire motorcycle with a mild detergent or car wash soap using a sponge or soft cloth. The sponge or cloth should be frequently soaked in the soap solution.

*NOTE: Clean the motorcycle with cool water immediately after riding on road salt or riding along the coast. Be sure to use cool water because warm water can hasten corrosion.*

*NOTE: Avoid spraying or allowing water to flow over the following places:*

- Ignition switch
- Spark plugs
- Fuel tank cap
- Fuel injection system
- Brake master cylinders
- CVT cooling louver
- Throttle cable boots

## **NOTICE**

**High pressure washers such as those found at coin-operated car washes have enough pressure to damage the parts of your motorcycle. It may cause rust, corrosion and increase wear. Parts cleaner can also damage motorcycle parts.**

**Do not use high pressure washers to clean your motorcycle. Do not use parts cleaner on throttle body and fuel injection sensors.**

3. Once the dirt has been completely removed, rinse off the detergent with running water.
4. After rinsing, wipe off the motorcycle with a wet chamois or cloth and allow it to dry in the shade.
5. Check carefully for damage to painted surfaces. If there is any damage, obtain "touch-up" paint and "touch-up" the damage following the procedure below:
  - a. Clean all damaged spots and allow them to dry.
  - b. Stir the paint and "touch-up" the damaged spots lightly with a small brush.
  - c. Allow the paint to dry completely.

*NOTE: The headlight lens can be fogged after washing the motorcycle or riding in the rain. Headlight fogging will be cleared gradually when the headlight is turned on. When clearing the headlight lens fogging, run the engine to avoid battery discharge.*

## **NOTICE**

**Cleaning your motorcycle with any alkaline or strong acid cleaner, gasoline, brake fluid, or any other solvent will damage the motorcycle parts.**

**Clean only with soft cloth and warm water with mild detergent.**

## **WINDSHIELD CLEANING**

Clean the windshield with a soft cloth and warm water with a mild detergent. If scratched, polish with a commercially available plastic polish. Replace the windshield if it becomes scratched or discolored so as to obstruct view. When replacing the windshield, use a Suzuki replacement windshield.

## **SPEEDOMETER DISPLAY CLEANING**

When the speedometer display is to be cleaned, wipe gently using a moist cloth.

### ***NOTICE***

**When the speedometer display is wiped or rubbed aggressively using a dry cloth, the display might be scratched.**

**Use a moist soft cloth.**

## **WAXING THE MOTORCYCLE**

After washing the motorcycle, waxing and polishing are recommended to further protect and beautify the paint.

- Only use waxes and polishes of good quality.
- When using waxes and polishes, observe the precautions specified by the manufacturers.

## **SPECIAL CARE FOR MATTE FINISH PAINT**

Do not use polishing compounds or waxes that contain polishing compounds on surfaces which have a matte finish. The use of polishing compounds will change the appearance of the matte finish.

Solid type waxes may be difficult to remove from surfaces with a matte finish.

Friction while riding, excessive rubbing or polishing of a surface with a matte finish will change its appearance.

## INSPECTION AFTER CLEANING

For extended life of your motorcycle, lubricate it according to the “LUBRICATION POINTS” section.

### **⚠ WARNING**

**Operating the motorcycle with wet brakes can be hazardous. Wet brakes may not provide as much stopping power as dry brakes. This could lead to an accident.**

**Test your brakes after washing the motorcycle, while riding at slow speed. If necessary, apply the brakes several times to let friction dry out the linings.**

Follow the procedures in the “INSPECTION BEFORE RIDING” section to check your motorcycle for any problems that may have arisen during your last ride.





# CONSUMER INFORMATION

---

WARRANTIES .....	10-2
EMISSION CONTROL SYSTEMS .....	10-3
REPORTING SAFETY DEFECTS .....	10-4
TAMPERING WITH NOISE CONTROL SYSTEM PROHIBITED .....	10-5
ON-BOARD MOTORCYCLE COMPUTER DATA INFORMATION .....	10-6
SERIAL NUMBER LOCATION .....	10-7
LOCATION OF LABELS .....	10-8



## CONSUMER INFORMATION

### WARRANTIES

The warranties for your motorcycle are explained in a separate warranty policy booklet given to you at the time of sale. Please read this booklet carefully so you can understand your rights and responsibilities. The following warranties are provided with your motorcycle:

- On-Road Motorcycle Limited Warranty
- Motorcycle Federal Emission Control System Limited Warranty
- California Emission Control System Limited Warranty (Applies ONLY to Suzuki street-legal emission-controlled motorcycles certified for sale and registered in California.)

Suzuki limited warranties and the Federal and California Emission Control System Limited Warranty may not cover damage caused by modifications that would change the original vehicle specifications including, without limitation, modifications of any emission-related parts such as the carburetor(s), fuel injection system components, the engine control module, air suction system components, the catalytic converter (if equipped), evaporative emission control system components, etc.

## **EMISSION CONTROL SYSTEMS**

Your vehicle is subject to U.S. Environmental Protection Agency (EPA) and California Air Resources Board (CARB) emission regulations. These regulations set specific standards for exhaust emission output levels and fuel permeation emissions, as well as particular servicing requirements.

### **Exhaust Emission Control System**

The exhaust emission control system of your vehicle includes a number of parts. While the emission-related parts may vary from model to model, they generally include components of the air induction system, fuel system, ignition system, and exhaust gas recirculation system, as well as devices such as catalytic converters, emission-related sensors, and electronic control units.

### **Evaporative Emission Control System (if equipped)**

The evaporative emission control system of your vehicle consists of the carbon canister, fuel tank, fuel hoses, and fuel vapor hoses. These parts incorporate technologies to control fuel evaporative emissions.

## **Servicing Requirements**

It is essential to have your vehicle serviced according to the maintenance schedule in this manual to maintain good emission performance and to preserve your emission warranty coverage. If parts replacement is necessary, replace the parts with Genuine Suzuki parts or their equivalent. Installing improper replacement parts or performing improper adjustments can cause your vehicle to exceed emission level limits. Tampering with emission-related components in a manner which defeats or reduces the effectiveness of these components is prohibited by federal and California law.

## **REPORTING SAFETY DEFECTS**

If you believe that your vehicle has a defect which could cause a crash or could cause injury or death, you should immediately inform the National Highway Traffic Safety Administration (NHTSA) in addition to notifying Suzuki Motor of America, Inc.

If NHTSA receives similar complaints, it may open an investigation, and if it finds that a safety defect exists in a group of vehicles, it may order a recall and remedy campaign. However, NHTSA cannot become involved in individual problems between you, your dealer, or Suzuki Motor of America, Inc.

To contact NHTSA, you may either call the Vehicle Safety Hot Line toll-free 1-888-327-4236 (TTY: 1-800-424-9153); go to <http://www.safercar.gov>; or write to: Administrator, NHTSA, 1200 New Jersey Ave., S.E., Washington DC 20590. You can also obtain other information about motor vehicle safety from <http://www.safercar.gov>.

To contact Suzuki Motor of America, Inc., owners in the continental United States can call toll-free 1-800-444-5077, or write to: Suzuki Motor of America, Inc. Motorcycle Customer Service P.O. Box 1100, Brea, CA 92822-1100.

For owners outside the continental United States, please refer to the distributor's address listed on your Warranty Information brochure.

## **TAMPERING WITH NOISE CONTROL SYSTEM PROHIBITED**

Federal law prohibits the following acts or the causing thereof;

1. The removal or rendering inoperative by any person other than for purposes of maintenance, repair, or replacement, of any device or element of design incorporated into any new vehicle for the purpose of noise control prior to its sale or delivery to the ultimate purchaser or while it is in use, or
2. The use of the vehicle after such device or element of design has been removed or rendered inoperative by any person.

Among those acts presumed to constitute tampering are the acts listed below:

- Removing or puncturing the muffler, baffles, header pipes, screen type spark arrester (if equipped) or any other component which conducts exhaust gases.
- Replacing the exhaust system or muffler with a system or muffler not marked with the same model specific code as the code listed on the Motorcycle Noise Emission Control Information label, and certified to appropriate EPA noise standards.

- Removing or puncturing the air cleaner case, air cleaner cover, baffles, or any other component which conducts intake air.

Whenever replacing parts on your motorcycle, Suzuki recommends that you use genuine Suzuki replacement parts or their equivalent.

## **ON-BOARD MOTORCYCLE COMPUTER DATA INFORMATION**

Your motorcycle is equipped with on-board computer systems which monitor and control several aspects of motorcycle performance, including the following:

- Emission-related components and engine parameters such as engine speed and throttle position are monitored to provide emission control and to provide optimum fuel economy. Your motorcycle also has an on-board diagnostic system which monitors and records information about emission-related malfunctions.
- If your motorcycle is equipped with antilock brakes, conditions such as motorcycle speed and brake performance are monitored, so that the ABS system can provide effective antilock braking.

Some information may be stored by the on-board computer when malfunctions occur. This stored information can assist technicians in repairing the motorcycle. To read the stored information, special equipment is needed and access to the motorcycle or storage device is required. In addition, once Suzuki collects or receives data, Suzuki may use the data for research conducted by Suzuki, make the data available for outside research if need is shown and confidentiality is assured, or make summary data which does not identify specific motorcycles available for outside research.

Others, such as law enforcement personnel, may have access to the special equipment that can read the information if they have access to the motorcycle or storage device.

## SERIAL NUMBER LOCATION

You need to know the frame and engine serial numbers to get title documents for your motorcycle. You also need these numbers to help your dealer when you order parts.

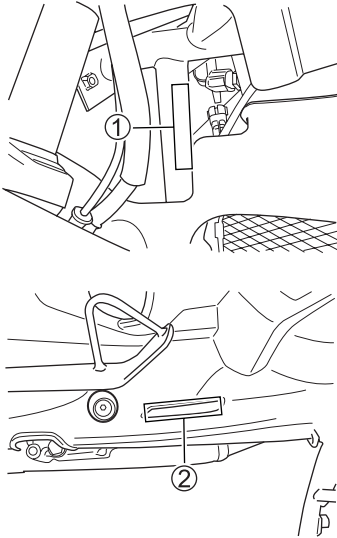

The frame number ① is stamped on the frame as shown in the illustration. The engine serial number ② is stamped on the engine.

Write down the serial numbers here for your future reference.

Frame No.:

Engine No.:

## LOCATION OF LABELS

Read and follow all of the warnings labeled on your motorcycle. Make sure you understand all of the labels. Keep the labels on your motorcycle. Do not remove them for any reason.

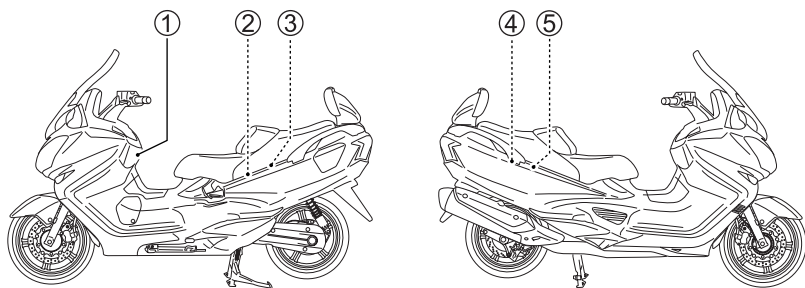

①

<b>⚠ WARNING</b>	
<b>To reduce the risk of injury:</b>	
<ul style="list-style-type: none"> <li>• Wear a helmet, eye protection, and protective clothing.</li> <li>• Read owner's manual carefully.</li> </ul>	

②

COLD TIRE PRESSURE	SOLO RIDING			DUAL RIDING		
	kPa	kgf/cm <sup>2</sup>	psi	kPa	kgf/cm <sup>2</sup>	psi
FRONT	225	2.25	33	225	2.25	33
REAR	280	2.80	41	280	2.80	41
		FRONT		REAR		
TIRE SIZE		120/70R15M/C 56H		160/60R14M/C 65H		
TYPE	BRIDGESTONE	TH01F		TH01R M		

③

**VEHICLE EMISSION CONTROL INFORMATION**

SUZUKI MOTOR CORPORATION  DISPLACEMENT :  cc

ENGINE FAMILY :

EVAP FAMILY :

PERMEATION FAMILY :

EXHAUST EMISSION CONTROL SYSTEM :

ENGINE TUNE-UP SPECIFICATIONS : ALL ADJUSTMENTS ARE TO BE PERFORMED WITH TRANSMISSION IN NEUTRAL

VALVE LASH :

FUEL :

IDLE SPEED :

ENGINE OIL : API SF / SG OR API SH / SJ WITH JASO MA, AND VISCOSITY RATING OF SAE 10W-40

REFER TO YOUR OWNER'S MANUAL FOR ADDITIONAL MAINTENANCE INSTRUCTIONS

THIS VEHICLE CONFORMS TO U. S. EPA AND CALIFORNIA REGULATIONS APPLICABLE TO  MODEL YEAR NEW MOTORCYCLES AND IS CERTIFIED TO  (EPA) AND  (CALIFORNIA) g/km HC + NOx ENGINE FAMILY EXHAUST EMISSION STANDARDS

④

The owner's manual contains important safety information and instructions which should be read carefully before operating the vehicle. If the vehicle has been resold, obtain the owner's manual from the previous owner or contact your local SUZUKI dealer for assistance.

⑤

**⚠ WARNING**

Never exceed the maximum loading capacity. Exceeding maximum loading capacity can cause loss of control.

**Maximum loading capacity**

- Trunk : 10kg (22lbs)
- Front box : 1.5kg (3lbs)
- Front small box, R/L : Each 0.5kg (1lbs)

- Place helmets as shown.
- Confirm the seat is locked.

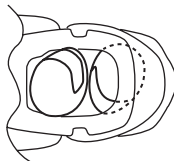



# SPECIFICATIONS

## DIMENSIONS AND CURB MASS

Overall length .....	2265 mm (89.2 in)
Overall width.....	810 mm (31.9 in)
Overall height .....	1420 mm (55.9 in)
Wheelbase .....	1585 mm (62.4 in)
Ground clearance.....	125 mm (4.9 in)
Seat height .....	760 mm (29.9 in)
Curb mass .....	281 kg (619 lbs)

## ENGINE

Type .....	4-stroke, liquid-cooled, DOHC
Number of cylinders .....	2
Bore .....	75.5 mm (2.972 in)
Stroke .....	71.3 mm (2.807 in)
Displacement.....	638 cm <sup>3</sup> (38.9 cu. in)
Compression ratio .....	11.2 : 1
Fuel system .....	Fuel injection
Air cleaner .....	Non-woven fabric element
Starter system .....	Electric starter
Lubrication system .....	Wet sump

## DRIVE TRAIN

Clutch .....	Wet multi-plate, automatic, centrifugal type
Primary reduction ratio .....	1.333 (88/66)
Gearshift pattern .....	Automatic and Manual shift
Automatic transmission ratio .....	Variable (1.800 – 0.465)
Secondary reduction ratio .....	3.934 (39/31 × 43/25 × 40/22)
Final reduction ratio.....	1.580 (32/31 × 31/32 × 34/31 × 49/34)
Drive system.....	Gear drive

## CHASSIS

Front suspension .....	Telescopic, coil spring, oil damped
Rear suspension .....	Swingarm type, coil spring, oil damped
Front fork stroke .....	110 mm (4.3 in)
Rear wheel travel.....	100 mm (3.9 in)
Caster.....	25°25'
Trail.....	103 mm (4.06 in)
Steering angle .....	41° (right and left)
Turning radius.....	2.7 m (8.9 ft)
Front brake .....	Disk brake, twin
Rear brake.....	Disk brake
Front tire size .....	120/70R15M/C 56H, tubeless
Rear tire size .....	160/60R14M/C 65H, tubeless

## ELECTRICAL

Ignition type .....	Electronic ignition (Transistorized)
Spark plug .....	NGK CR8E or DENSO U24ESR-N
Battery .....	12V 43.2 kC(12 Ah)/10HR
Generator .....	Three-phase A.C. Generator
Main fuse .....	40A
CVT fuse .....	40A
Fuse .....	15/15/10/10/15/15/15/15/20/3/20/5A
Headlight .....	12V 60/55W (H4) × 2
Position light .....	LED
Brake light/Taillight.....	12V 21/5W × 2
License plate light.....	12V 5W
Trunk box light .....	12V 5W
Turn signal light .....	12V 21W
Instrument panel light.....	LED
Malfunction indicator light.....	LED
Oil pressure indicator light.....	LED
Brake lock indicator light.....	LED
High beam indicator light.....	LED
Turn signal indicator light.....	LED
Freeze indicator light .....	LED
ABS indicator light .....	LED

## CAPACITIES

Fuel tank.....	15.0 L (4.0 US gal)
Engine oil, oil change .....	2600 ml (2.7 US qt)
With filter change .....	2900 ml (3.1 US qt)
Transmission oil, oil change .....	360 ml (12.2 US oz)
Overhaul .....	400 ml (13.5 US oz)
Final gear oil, oil change.....	300 ml (10.1 US oz)
Overhaul.....	430 ml (14.5 US oz)
Coolant .....	1600 ml (1.7 US qt)

# INDEX

---

- A**  
ACCESSORIES AND  
LOADING ..... 1-5  
ACCESSORY INSTALLATION  
GUIDELINES..... 6-2  
ACCESSORY USE ..... 6-2  
AIR CLEANER ..... 7-13
- B**  
BACKREST  
ADJUSTMENT ..... 3-32  
BATTERY ..... 7-7  
BE EXTRA SAFETY-  
CONSCIOUS ON  
BAD WEATHER DAYS ..... 1-4  
BE STREET SMART ..... 1-6  
BRAKE LOCK LEVER..... 3-27  
BRAKES..... 7-29  
BREAK-IN ..... 4-2
- C**  
CARRYING A  
PASSENGER ..... 1-5  
CATALYTIC  
CONVERTER..... 7-44  
CONCLUSION ..... 1-6  
CORROSION  
PREVENTION..... 9-3  
CVT FILTER..... 7-17
- E**  
EMISSION CONTROL  
SYSTEMS ..... 10-3  
ENGINE COOLANT ..... 7-19  
ENGINE COOLANT  
SOLUTION ..... 2-6  
ENGINE IDLE SPEED  
INSPECTION..... 7-16  
ENGINE OIL ..... 2-4,7-21
- F**  
FINAL GEAR OIL ..... 2-5  
FRONT SMALL BOX..... 3-30  
FRONT TRUNK..... 3-29  
FUEL ..... 2-2  
FUEL TANK CAP ..... 3-28  
FUSES..... 7-42
- H**  
HELMET HOLDER ..... 3-31

---

<b>I</b>	
IF A COLLISION IS IMMINENT, DO SOMETHING .....	1-3
IF YOU DON'T HAVE A HELMET, BUY A HELMET AND WEAR IT EVERY TIME YOU RIDE .....	1-2
IGNITION SWITCH .....	3-5
IGNITION SYSTEM CHECK.....	8-2
INSPECTION AFTER CLEANING .....	9-7
INSPECTION BEFORE RIDING.....	1-5,4-3
INSTRUMENT PANEL .....	3-8

<b>K</b>	
KEY .....	3-5
KNOW YOUR LIMITS .....	1-4

<b>L</b>	
LABELS.....	1-6
LEFT HANDLEBAR.....	3-20
LIGHT BULB REPLACEMENT .....	7-37
LOADING GUIDELINES .....	6-4
LOADING LIMIT .....	6-3
LOCATION OF LABELS .....	10-8
LOCATION OF PARTS.....	3-2
LUBRICATION POINTS.....	7-6

<b>M</b>	
MAINTENANCE SCHEDULE .....	7-2
MODIFICATION .....	6-5
MOST ACCIDENTS CAN BE AVOIDED .....	1-2
MOTORCYCLE CLEANING .....	9-4
MOTORCYCLE SAFETY FOUNDATION'S "RIDING TIPS AND PRACTICE GUIDE" HANDBOOK (FOR OWNERS IN USA) .....	1-5

<b>O</b>	
ON-BOARD VEHICLE COMPUTER DATA INFORMATION .....	10-6
OUTPUT TERMINAL.....	3-34

<b>P</b>	
PRACTICE AWAY FROM TRAFFIC .....	1-5
PROCEDURE FOR RETURNING TO SERVICE.....	9-3

---

## R

REAR SUSPENSION.....	3-34
REPORTING SAFETY DEFECTS.....	10-4
RIDING ON HILLS (MANUAL mode).....	5-5
RIGHT HANDLEBAR .....	3-25

## S

SERIAL NUMBER LOCATION.....	10-7
SIDE STAND/IGNITION INTERLOCK SYSTEM.....	7-36
SPARK PLUG .....	7-10
SPECIAL SITUATIONS REQUIRE SPECIAL CARE .....	1-4
STAND .....	3-33
STARTING OFF .....	5-4
STARTING THE ENGINE .....	5-2
STOPPING AND PARKING .....	5-5
STORAGE PROCEDURE.....	9-2

## T

TAMPERING WITH NOISE CONTROL SYSTEM PROHIBITED.....	10-5
THROTTLE CABLE PLAY .....	7-16
TIRES.....	7-33
TOOLS .....	7-6
TRANSMISSION OIL .....	2-5
TRANSMISSION OIL AND FINAL GEAR OIL .....	7-26
TRUNK .....	3-31
TRUNK BOX LIGHT SWITCH .....	3-32

## W

WARRANTIES.....	10-2
-----------------	------